

INSTRUCTION MANUAL ILLUSTRATED PARTS AND PRICE LIST FOR THE MODEL L GRAVELY TRACTOR AND ATTACHMENTS

THE GRAVELY TRACTOR
LUBRICATION

USE ONLY HIGH GRADE LUBRICANTS SUCH AS:
ENGINE ----- Mobiloil AF (SAE 40)
BELOW 32° F. - Mobiloil Arctic (SAE 20)
WITH MACHINE LEVEL FILL TO TRY COCK
LOCATED ON SIDE OF CHASSIS.
FUEL ----- USE GOOD GASOLINE LIKE
Mobilgas (REGULAR GRADE)
MOWERS & ACCESSORY PARTS - USE GEAR
OILS SUCH AS - Mobilube C (SAE 140)
FOR WINTER -- Mobilube CW (SAE 90)

READ INSTRUCTION MANUAL CAREFULLY

MFD. BY **GRAVELY**
DUNBAR, WEST VIRGINIA, U.S.A.

MODEL **L** TRACTOR NO.

SORRY—due to increased costs, all prices of repair parts in this Instruction Book are INCREASED 15%

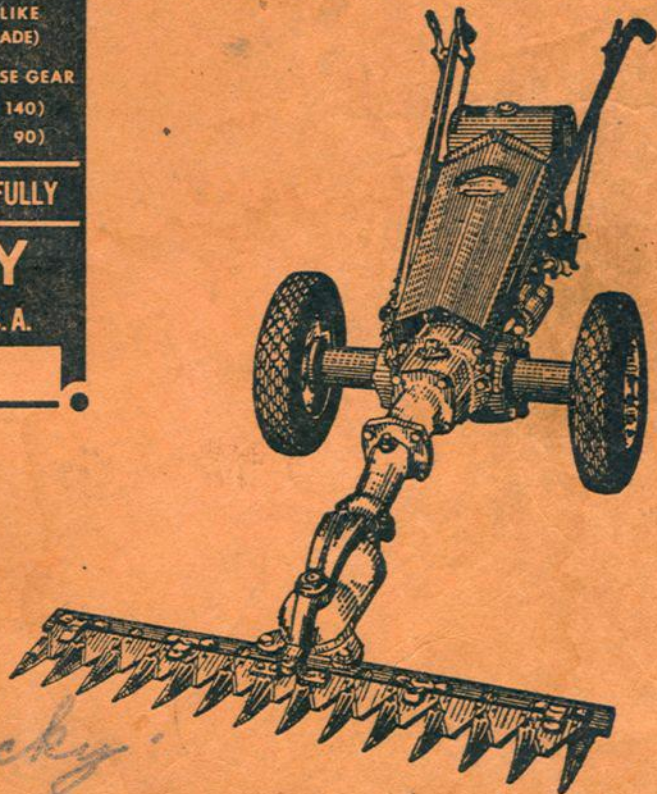

*Gravelly Co. - Lucky
E. Main St.
Douglas 2118*

Gravelly Motor Plow and Cultivator Company

Dunbar, West Virginia, U.S.A.

INSTRUCTIONS

For Using Your GRAVELY Parts And Price List

INTRODUCTION

The aim in making up this Parts and Price List Book has been to present simply and as clearly as possible parts of the GRAVELY Tractor and each attachment in the order that they are assembled or disassembled. In most cases each photograph consists of an entire assembly; in other cases however, to avoid jamming together and causing confusion in identifying and ordering parts, the complete assembly may appear in several photographs. For example: The tractor itself--the motor, the chassis, and wheel assembly, all appear in different photographs. This has been done for your convenience in clearly selecting the part or parts that you need.

At the top of each photograph there appears the plate identification, a letter of the alphabet. Also, the name of the plate is given. For example: The first photograph is Plate A--Motor & Pin Plate Assembly. Directly beneath the photograph, and in some cases beside, is the Parts and Price List. Where two or more photographs appear on the same page, the plate letter and identification will head the Parts and Price List.

Each part appearing in a photograph has been given a number, referred to as the PHOTO NO. in the Parts and Price List. As nearly as possible, the parts are shown and numbered in the order of their assembly. Ordinarily the number appears directly beneath the part, but where ever it does not, it will be found beside or at the top enclosed in a circle with an arrow pointing to the part it designates. In other cases a number may appear with a broken circle partially enclosing a part. Some photographs may have two or more parts designated by the same number--bolts, nuts, washers, etc.--in this case they are the same, used in different places of the assembly. In some photographs, space did not permit numbering of the duplicate parts; however, this is rare and if you should discover the part you need has no number, there will appear on the same plate an identical part with a part number. That number should be used in identifying your part in the Parts and Price List.

HOW TO FIND A PART

Here is the procedure for you to follow in identifying and ordering a replacement part. (As an example we are using the Muffler--this will aid you in tracing the part or parts that you need.):

FIRST Select the correct photograph, which in this case is the first one, Plate A, Motor & Pin Plate Assembly.

SECOND Find the part that you need. In our example it is the Muffler.

THIRD Determine the correct photo number of your part. Directly beneath the Muffler is the number 24.

FOURTH Now we choose the correct Parts and Price List. (Because Plate A is the only photograph on the page we know that the Parts and Price List appearing directly beneath is the correct one.)

FIFTH In the first column marked PHOTO NO., find number 24.

SIXTH To the right of the first column is the column marked PART NO., PHOTO NO. 24 is part number L 816.

SEVENTH The third column marked DESCRIPTION serves as a check for you in identifying the part that you need. You see there the word Muffler, the part that we wanted.

EIGHT The fourth and last column marked PRICE gives the price of your part. In the case of the Muffler, the price given is \$3.85.

HOW TO ORDER A PART

All prices are F. O. B. Dunbar, West Virginia. If your part is slightly more than what appears in the price column of the Parts and Price List it is because shipping charges have been added.

The initials NS appearing in the PHOTO NO. column stand for NOT SHOWN. It was not possible to photograph some parts, however those parts are listed. If you cannot find your part on the plate refer to the Parts and Price List under the initials NS in the PHOTO NO. column. You can identify your part in the DESCRIPTION column.

This is important: Your repair parts are ordered directly from your dealer. The only information that he needs is the PART NO. and the quantity needed. For prompt delivery order by PART NO. and quantity only. This will eliminate any possibility of mistakes, and it will also save your valuable time. Unless otherwise stated, all prices in the Parts and Price List are for Single Units.

All Prices f.o.b. Dunbar, W.Va.-Prices Subject To Change Without Notice

GEAR SELECTOR HANDLE

GAS THROTTLE

SPEED SELECTOR HANDLE

SPARK PLUG

GAS TANK CAP

OIL BATH AIR CLEANER

ZENITH CARBURETOR

MAGNETO

A C OIL FILTER

ATTACHMENT CLUTCH LEVER

OIL FILLER CAP

ATTACHMENT BOLTS

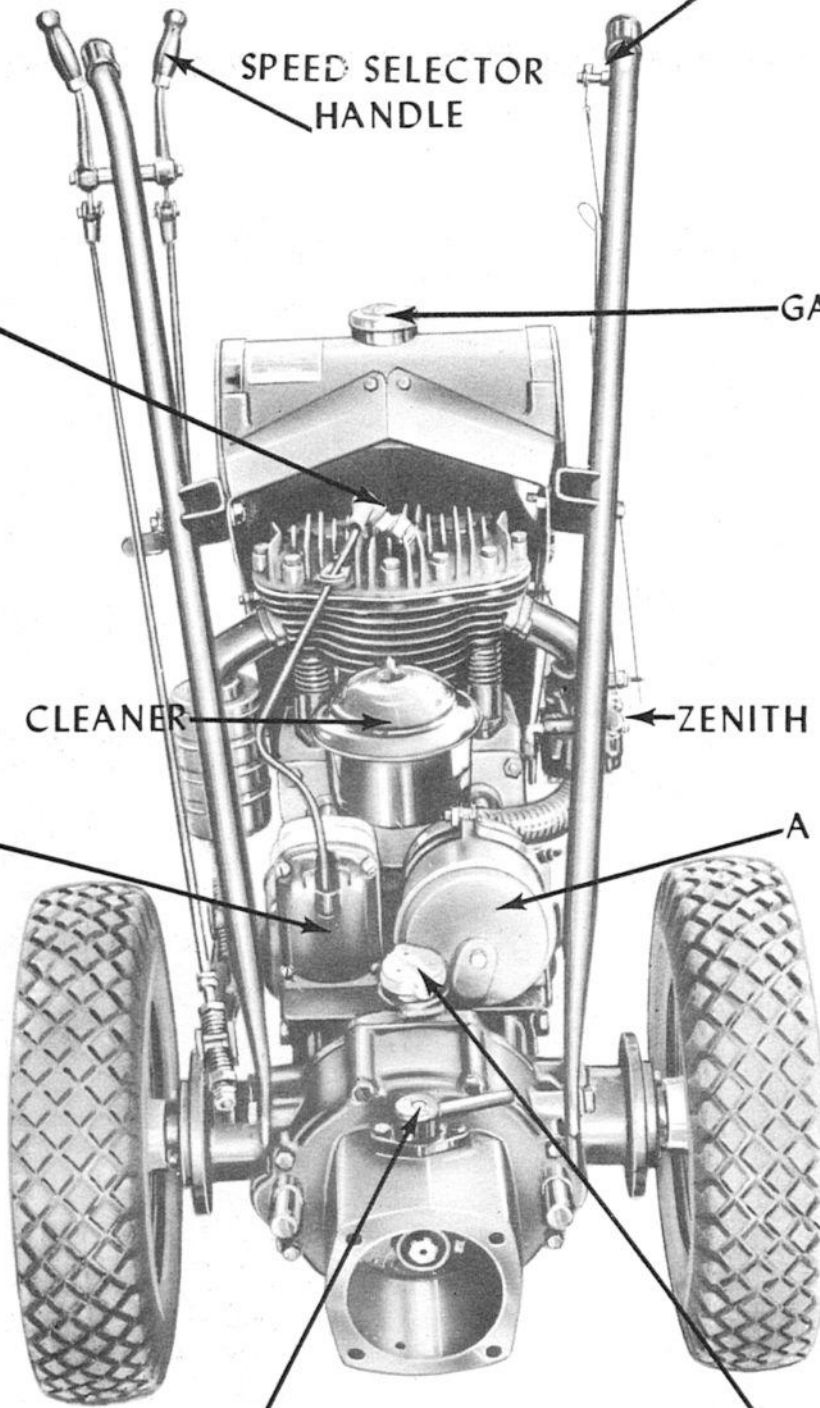

I N D E X

Operating Instructions.....	Model L Tractor----	Page 6
Motor & Pin Plate Assembly.....	Plate A----	Page 10
Crankcase, Flywheel & Magneto Assembly.....	Plate B----	Page 11
Chassis, Advance Casting & Oil Filter Assembly.....	Plate C----	Page 12
Internal Chassis & Worm Gear Assembly.....	Plate D----	Page 13
Fan Assembly.....	Plate E----	Page 13
Return U Assembly.....	Plate E-1--	Page 13
External Parts.....	Plate F----	Page 14
Slip Clutch & Starting Strap.....	Plate F-1--	Page 14
Operating Instructions.....	SM Sickle Mower ----	Page 15
Sickle Mower Column Assembly.....	Plate G----	Page 16
Sickle Mower Head Assembly.....	Plate H----	Page 16
Wheel Assembly.....	Plate I----	Page 16
3 Inch Sickle Bar.....	Plate J----	Page 17
2 Inch Sickle Bar.....	Plate K----	Page 17
Power Take Off.....	Plate L----	Page 18
Operating Instructions.....	RP Rotary Plow----	Page 18
Rotary Plow.....	Plate M----	Page 19
Rotary Plow.....	Plate N----	Page 19
Rotary Plow.....	Plate O----	Page 20
Extension Axle.....	Plate P----	Page 20
Turn Plow & Rear Hitch.....	Plate Q----	Page 20
Gear Reduction Wheels.....	Plate R----	Page 21
Snow Plow.....	Plate S----	Page 21
Snow Plow Blade Assembly.....	Plate T----	Page 21
Power Brush Drive Assembly.....	Plate U----	Page 22
Power Brush Drive Gears.....	Plate V----	Page 22
Power Brush.....	Plate W----	Page 23
Power Brush Caster Assembly.....	Plate X----	Page 23
Tool Holder.....	Plate Y----	Page 24
Riding Sulky.....	Plate Z----	Page 24
Operating Instructions.....	Rotary Reel Mower ----	Page 25
Operating Instructions.....	Gang Mower ----	Page 26
Rotary Mower Drive Assembly.....	Plate AA----	Page 28
Rotary Mower Reel Assembly.....	Plate BB----	Page 29
Gang Mower Drive Assembly.....	Plate CC----	Page 30
Gang Mower Reel Assembly.....	Plate DD----	Page 31
Operating Instructions.....	Rotary Saw----	Page 32
Rotary Saw.....	Plate EE----	Page 34
Operating Instructions.....	Disc Harrow----	Page 34
Installation & Adjustment Instructions.....	Governor----	Page 35
Parts & Price List.....		Page 36
Operating Instructions.....	Peg Type Harrow---	Page 37
Operating Instructions.....	Transportation Cart----	Page 37
Operating Instructions.....	Water Ballast Roller----	Page 38
Cushion.....		Page 38
Tire Chain.....		Page 38
Tractor Cover.....		Page 38
Sickle Grinder.....		Page 38
Puncture Proof Tire Tubes.....		Page 38
Oil Pressure Gauge.....		Page 38
Operating Instructions.....	Snow Blower----	Page 39
Operating Instructions.....	Wing Transport Bracket----	Page 39

November 30, 1950

THIS SUPERSEDES ALL OTHER PARTS & PRICE LISTS
ISSUED PRIOR TO THIS DATE

Printed in U. S. A.

For GRAVELY TRACTORS, Serial No. 53500 to -----

OPERATING INSTRUCTIONS FOR THE MODEL L GRAVELY TRACTOR

FILL THE TANK WITH GASOLINE

Your engine will give you good results if you use a good gasoline. We recommend Mobilgas Regular for best results. To fill the tank, merely take off the cap and pour in the gasoline. Tank capacity is about two gallons, and should run you about 8 hours under normal working conditions. We do not recommend any Hi-Test gasoline.

FILL WITH OIL

Remove Filler Cap on the Chassis Top and pour in about five pints of good grade of motor oil. We recommend: For summer use, Mobiloil AF (SAE 40). In winter, Mobiloil Arctic (SAE 20). This lubricates both the motor and final drive as well. Realize the importance of always keeping oil up to the proper level. To check this, have your machine setting completely level. Notice on the right-hand side of the Chassis a Try Cock Valve. Loosen this Valve. If oil runs out, you have an ample supply.

When using your tractor on extremely steep hills be positive that a full five pints are in it so as to give an ample supply when the machine is tilted at an angle.

CRANKING MOTOR

You must attach one of the attachments before attempting to start the motor. Or use part no. 228, Attachment Boss Cover, \$1.65.

Wind the Strap clockwise around the Fan Pulley, which is on the rear of the engine. Before spinning be sure both Clutch Levers on the right Handle are each in the middle, or neutral, position

The Magneto on the motor is equipped with an Impulse Coupling. This means easier starting. A good spark can be produced without the necessity of too fast a spin. GET A GOOD FIRM GRIP ON THE STARTING STRAP HANDLE WHEN CRANKING AND DON'T LET LOOSE. Experiment with the easiest method for you to crank. Some users find by backing the motor so that it will be off compression that they can crank much easier. Others prefer to spin faster. Use whichever method seems easiest to you.

SELECTING SPEEDS

You have two forward and two reverse speeds. TO GO FORWARD IN LOW GEAR, push left hand Clutch Lever (on right handle) as far forward as it will go. Then, pull right-hand Lever as far backward and downward as it will go. Your machine is now moving forward in low speed. TO CHANGE TO HIGH, simply pull left-hand Lever only as far backward and downward as it will go. TO REVERSE, push right-hand Lever forward. Then, select low and high speed with left hand lever same as for forward travel.

- REMEMBER:
1. Left-hand lever is selector, high and low travel speed.
 2. Right-hand lever is for forward and reverse.

TRANSMISSION CLUTCH

A double-acting cone type Clutch is used. To take up for wear, simply tighten nuts on ends of Clutch Rods. After first using and wearing in, this might be necessary, but after that adjustment nothing should be needed for some time. Clutch will give ample warning by tendency to slip under load. Unless that happens, do not tamper with it.

ATTACHING TOOLS

All Power Attachments (and most others as well) are bolted directly on front of Tractor by means of the four bolts. The cultivating toolholder, snow plow, etc., are not power driven and do not require any clutch or meshing of gears.

When attaching power attachments make sure that the THROW OUT LEVER IS IN THE OUT POSITION.

POWER ATTACHMENT CLUTCHES

Each Power Attachment has an individual safety slip clutch, which is adjusted by us and which should be just tight enough to stall engine. If this becomes loose take up tension springs.

POWER ATTACHMENT THROWOUT LEVER

This is used to free Power Attachments when going to and from a job, etc. Always idle motor and have control levers in the neutral position when putting attachments in gear.

A method which will prevent raking the gears when you are putting attachments in gear is as follows:

Idle motor. Then, be sure the speed selector is in the neutral position. Use the other lever, and begin to put the tractor in reverse--use care, ease it into gear until the Tractor Engine begins to "pull down" and/or the tractor begins to barely creep backwards. Then put the attachment in gear. You will find that this will prevent any raking and will add many months of life to your Attachment Clutch.

OILING INSTRUCTIONS

When the Tractor is new the motor oil should be changed after the first 15 to 20 hours of running. After breaking in this changing should be according to usage. Working conditions as well as hours of running determine this. You should check oil as to the body and the amount of sediment in it and change accordingly. We would say it would be a good habit to form to change oil after every 50 hours of running.

The Oil Filter should be renewed once a season. This too is dependent upon usage.

TO CHANGE OIL

Remove the Drain Plug on bottom of Chassis and allow oil to drain. IT IS WISE TO FLUSH OUT BY PRESSURE WHEN THIS IS DONE. Replace the Plug before refilling.

VALVE TOP OIL

When the motor is new and being run in, use Mobil Upperlube valve top oil mixed with the gasoline according to instructions found with such oil. IT IS ALSO WISE TO USE THIS BEFORE THE MACHINE IS STORED AWAY FOR ANY LENGTH OF TIME AND THERE IS A POSSIBILITY OF PARTS RUSTING.

THINGS TO DO TO AVOID TROUBLE

This is possibly the most important part of the instruction book. Unless the user reads and follows out the points which follow we cannot be responsible in case of trouble. The proverbial "ounce of prevention" truly applies to machinery of this type.

CHECKING OIL PUMP

The first and every time you start the motor make sure the oil pump is working. Remove the Filler Cap to see if a good steady stream is coming forth. IF IT ISN'T DO NOT OPERATE THE MOTOR ANY LONGER UNTIL THIS IS REMEDIED.

REMEDIES: 1. Check for Air leaks around Intake Oil Line and connections connecting from the motor to the chassis.

2. Check Oil Line: to make sure it isn't stopped up. Many times an obstruction is found in Oil Strainer Body. To clean this body, remove 6 Axle Housing Bolts on left side of tractor and pull out axle housing. Then you can get into the chassis to see the Oil Strainer Body. Without removing, make sure that oil screen on bottom of oil strainer body hasn't clogged up. If it is clogged the strainer body must be removed. This is done by first loosening the intake oil strainer nut. Then the oil strainer body can be worked out the left side of tractor.

In cases where lack of oil has caused your motor to burn out a bearing or connecting rod, when you replace these BE SURE AND CHECK THIS CLOGGING OF OIL. If that has caused your first trouble, even replacing new parts will not be the remedy.

DO NOT RUN MOTOR AT FULL SPEED UNTIL IT HAS BEEN RUN FOR AT LEAST A WEEK.

HAVE A REGULAR PERIOD TO GO OVER THE ENTIRE MACHINE AND TIGHTEN NUTS AND BOLTS THAT WILL BECOME LOOSE.

CHECK OFTEN FOR WEAR ON PARTS AND GET NEW ONES BEFORE OLD ONES BECOME WEAK AND BREAK. Such a breakage is liable to cause damage to other parts.

AIR CLEANER

Because of the abrasive effect of dust on all moving parts of the engine, and its effect on carbon deposits in the cylinder, it is of the utmost importance that you keep your Air Cleaner in place and see that all connections are tight. WE CANNOT MAKE OUR GUARANTEE VALID UNLESS THESE INSTRUCTIONS CONCERNING THE AIR CLEANER ARE STRICTLY ADHERED TO.

Instructions as to the amount of oil to be used with your Air Cleaner are on the Air Cleaner itself. Be sure to check the Air Cleaner after each day's use to see that it contains the proper amount of oil.

It is a good idea to clean your Air Cleaner itself frequently before adding fresh oil. Remember that should your Air Cleaner become clogged from dirt or dust, you are doing the same thing as running your tractor without any protection at all.

When the Tractor is used under dusty or similar conditions you should regularly clean the outside of the motor too, removing all waste that clings around the cylinder fins especially.

THINGS TO DO IN CASE OF TROUBLE

ENGINE HARD TO START: This may be due to any of the following: Improper carburetor adjustment; faulty ignition; interrupter contacts too wide; spark plug dirty; or points improperly spaced. Store the machine in a warm dry place in winter.

ENGINE FLOODED: If when cranking engine you notice a vapor coming from the exhaust, more particularly when it is hot, it is due to excess gasoline and it will not start until this excess is eliminated from the cylinder. Open the Vent on the Manifold Return U and allow the machine to set for a few minutes. It should start without any trouble.

ENGINE OVERHEATS: This may be due to insufficient oil supply; improper carburetor adjustment; magneto timing to engine too late; cylinder fins clogged; fan not working properly; excessive carbon in cylinder, etc.

ENGINE LOSES POWER: If the compression is poor, with a resultant loss of power, it may be remedied by the following: Reseat valves if leaking. Check Valve Tappets and adjust if necessary. Be sure the Piston Rings are not stuck in the grooves. If the compression loss is due to worn piston and rings, it will be necessary to replace these with new ones. If the cylinder is badly worn, it will be advisable to send it back to the factory to have it rebored and fitted with new and oversize piston and rings.

ENGINE STOPS SUDDENLY: If engine has been running nicely and stops suddenly, first see that you have gasoline in the tank. Remove spark plug and lay it on top of cylinder with cable connected. If you have a good spark, disconnect gasoline line from carburetor and see that gas flows freely. It may be possible there is dirt in the carburetor, or the lines may be plugged.

CHECKING ADJUSTMENT

Spark Plug Points should be cleaned and checked for clearance and set with a gap of .030. Valves should be checked for carbon or other like material that might get into the seats and cause leakage. Also, valves should be given .008" clearance between Valve Stem and Valve Plunger.

CARE OF TIRES

Always keep 35 to 40 pound pressure in the tires. Lower Pressure might possibly allow slippage on the rim thereby pinching and damaging the valve inlet ruining the tire inner tube.

Remember that these tires, whether ground-grip or all-weather type, have an inner tube and should thus be treated exactly like your automobile tire. Should trouble develop, remove the wheel by taking out the six rim bolts and repair the tire just as you would that of an automobile.

TIMING L MODEL ENGINE

Magneto should be set to fire 30 Degrees ahead of top dead center on the compression stroke (which is when both valves are closed).

To accomplish the 30 Degree ahead of top dead center firing, proceed as follows:

1. Remove Air Cleaner and Air Cleaner Bracket.
2. Loosen nut on Magneto Coupling.

3. Remove Cylinder head.
4. To ascertain the firing position of the crank, bring the piston to top dead center on the compression stroke (which is when both valves are closed).
5. While Piston is top dead center, measure how far it is from top of piston to top of cylinder wall. Record this measurement because it will have to be added to 5/16" when timing your Magneto with the motor.
6. Now turn the crank counter clockwise until the piston goes down the cylinder 5/16", plus what you recorded in Step #5, from the top of the cylinder wall.
7. While holding the Magneto Shaft Extension counter clockwise (in order to take up any backlash in the gears) rotate the Magneto impulse (Inoperative) until the timing marks line up.
8. Be sure there is at least 1/64" end play in the magneto coupling so that it will not cramp the impulse. Insert 1/64" feeler between fiber block and coupling flange before tightening nut. Tighten the magneto coupling nut while holding the timing marks together.
9. Now recheck your settings by backing the piston not more than 2" down the cylinder barrel (to avoid picking up Magneto Impulse) and reviewing the procedure to make sure any backlash has not thrown you off on your measurements.
10. When you are sure that piston measures properly from top of cylinder wall and at the same time Magneto timing marks are lined up together, lock the Coupling Nut in place by bending down tip on lock washer, replace Cylinder Head, Air Cleaner and Bracket.

STARTING THE TRACTOR

Under Normal Conditions

The proper method of starting the Gravelly engine is to pull the Choke wire all the way out and put the Gas one-third of the way down, just before beginning to crank the motor. Leave the wire out until the engine starts. Then gradually return the Choke Wire to its place as the engine warms up.

In Cold Weather

Cold weather usually affects the starting of any gasoline engine, so storing your Gravelly tractor in a heated shed or building will aid you in starting the engine.

Cold weather starting of the tractor differs somewhat from the way you start the Gravelly under normal conditions. First be sure the oil is light enough in weight. Mobiloil Artic Special SAE 10 is recommended for very severe conditions.

If SAE 10 is used and the tractor still refuses to start, pull the Choke Wire all the way out and put the Gas all the way down. Then crank the motor in the usual manner. As soon as the tractor starts, release the Choke Wire gradually just like under normal conditions but continue to choke at intervals until the tractor motor is well warmed up.

If the tractor still does not start, check it for mechanical difficulties, such as a defective spark plug, out of gas, water in the gas, etc.

If the tractor is mechanically all right to the best of your knowledge, and the above methods do not work, call your GRAVELLY Dealer.

STORING YOUR TRACTOR

One of the most important things in caring for your GRAVELLY Tractor is knowing how to store it when it is not in use.

First: Clean the Tractor thoroughly with gasoline or kerosene and a stiff brush.

Second: Put the Tractor in a dry place and jack it up. Clean the dirt from the tires. Clean out the air cleaner.

Third: Drain the crank case, flush with kerosene and refill with new oil. (Use a rust preventive oil if obtainable.) Operate the engine for two minutes to distribute the oil through the engine. Do not get the engine hot.

Fourth: Remove the spark plug and put $\frac{1}{2}$ pint Mobil-oil Artic Special SAE 10 in the cylinder. Turn over by hand several times; leave the piston on top dead center, and then replace the spark plug.

Fifth: Drain the gas tank and the carburetor.

TO START YOUR TRACTOR AGAIN

When the time comes for you to take your Tractor out of storage and get it ready for use again, there are six important steps if you want the Tractor to start immediately and work consistently.

First: Drain out any rust preventive oil used and replace it with Mobiloil A SAE 30.

Second: Remove spark plug and put $\frac{1}{4}$ pint of Mobil-oil Artic Special SAE 10 in cylinder. Turn over several times by hand. Replace spark plug.

Third: Fill gas tank with fresh Mobilgas. See that gas has reached carburetor, (by removing drain plug on bottom of carburetor until Mobilgas flows freely). Then replace drain plug.

Fourth: Pump up tires to 30 pounds pressure.

Fifth: If Oil Filter has not been replaced since last year, it is best to replace it with a new one.

Sixth: Start your Tractor in the usual manner.

STICKING VALVES

Occasionally you may find that suddenly--usually overnight--you have no compression. That means that you can spin the motor over by hand easily, and it will not start. When this is the case, you have an exhaust valve stuck in the open position.

To correct, remove the spark plug and head. Use a light penetrating oil (Mobiloil Artic Special SAE 10 mixed $\frac{1}{2}$ and $\frac{1}{2}$ with kerosene), putting it liberally around the valve stem. Then take a screwdriver and insert it in the slot in the top of the valve, and keep trying to turn the valve as the oil works down. The valve will usually free itself in a few minutes, and turn freely. Then remove the screwdriver and turn the engine over by hand, and if the valve works up and down as the engine turns over, your difficulty is solved. Replace head and spark plug and start engine. You may have to pull it several times until the oil and kerosene burn out, but it will start quickly.

CAUTION

It is always a good policy, after the tractor has been idle a day or more to try to turn the motor over by hand before you put the strap on it. Occasionally a valve will stick in the down position. If you try to start the motor with the valve stuck down you will tear off the Valve Cam, and usually knock a hole in the crankcase. If your tractor engine will not turn over by hand, follow the same procedure as outlined above until the valve is free.

Follow the advice given in these instructions under "Valve Top Oil." It is important enough to bear repeating: "Use Mobil Upperlube Valve Top Oil mixed with the gasoline according to the instructions with such oil." This will lubricate the head and valves, and prevent any valve sticking.

SLIP CLUTCH ADJUSTMENT

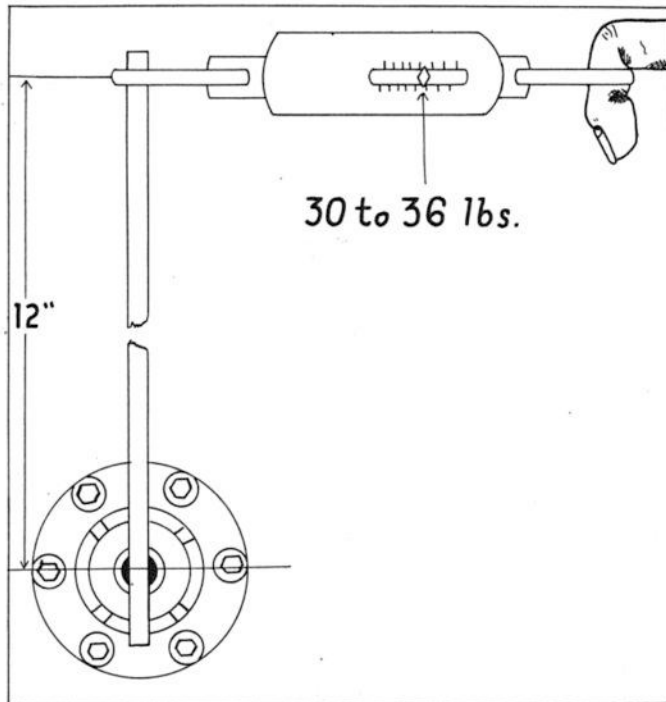

INSTRUCTIONS FOR ADJUSTING SAFETY SLIP CLUTCH

All L Model Attachments are equipped with safety slip clutches and it is of the utmost importance that these clutches be properly adjusted. If the clutch is too loose it will not efficiently drive the attachment. If too tight it may prove disastrous

to the transmission of the tractor. Due to the high velocity and weight of the fly wheels in the engine it would be impractical to build a transmission to stand the shock when getting an obstruction in the attachment.

We have taken recourse to a safety slip clutch to absorb all shocks that the attachments are subject to. The illustration shows the most practical method of adjustment. Place a flat bar in the driving slots, hook a pair of spring scales on the bar 12" from the center of clutch, adjust spring tension evenly so that it takes 30 to 36 lbs., to make the clutch slip.

This will transmit all of the engine power and still protect tractor and attachments from undue shocks.

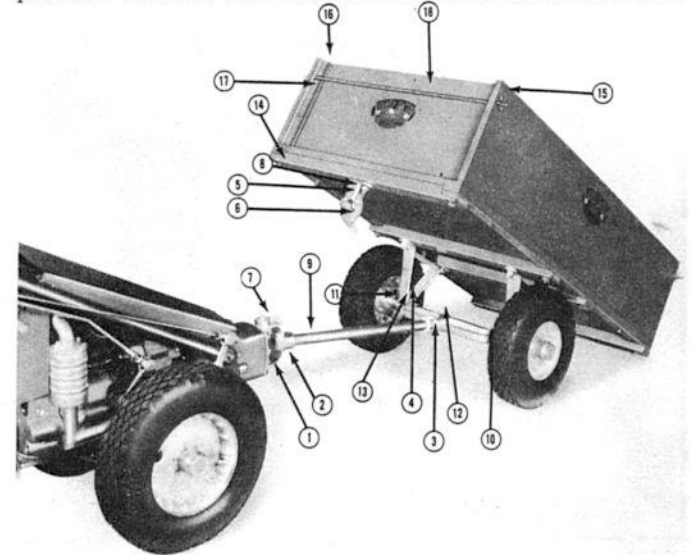

PARTS AND PRICE LIST

PHOTO No.	PART No.	DESCRIPTION	PRICE
1	A 107	Knuckle Bracket	2.90
2	A 108	Knuckle Fork	2.54
3	A 318	Thrust Collar	.80
4	A 110	Axle Bracket	2.25
5	A 111	Body Rest	1.15
6	A 112	Body Latch	.97
7	A 315	Knuckle Pin	.80
8	A 316	Body Latch Pin	.10
9	A 317	Draw Bar	1.45
10	A 109	Swivel Bracket	3.39
11	A 310	Axle	2.82
NS	A 319	Draw Bar Rivet	.08
12	M 480	Alemite Fitting	.09
13	801 A	Axle Set Screw	.14
NS	802 A	Knuckle Pin Set Screw	.10
NS	219-N	Axle Nut	.18
NS		3/8x 3-1/4 Carriage Bolt for Body	.11
NS	403-W	Axle Bracket Bolt Washer	.01
NS	194-S	3/8x 3 Carriage Bolt for Axle Bracket and Body Rest	.10
	A 314	Body Complete	25.00
	A 321	Wheels Complete	16.00
NS	606C	Cotter Key (Latch Pin)	.01
NS	A 323	Stanchion	.40
14	205-N	Carriage Bolt Nuts	.03
15	L 819 F	Wing Nut	.07
16	A 324	Side Board Cleat	.40
17		Cleat Rivet	.01
18	A 325	Tie Rod	.40
NS	401 W	Washers (Tie Rod)	.01
NS	124-S	Knuckle Bracket Screw	.05

PLATE A

Motor & Pin Plate Assembly

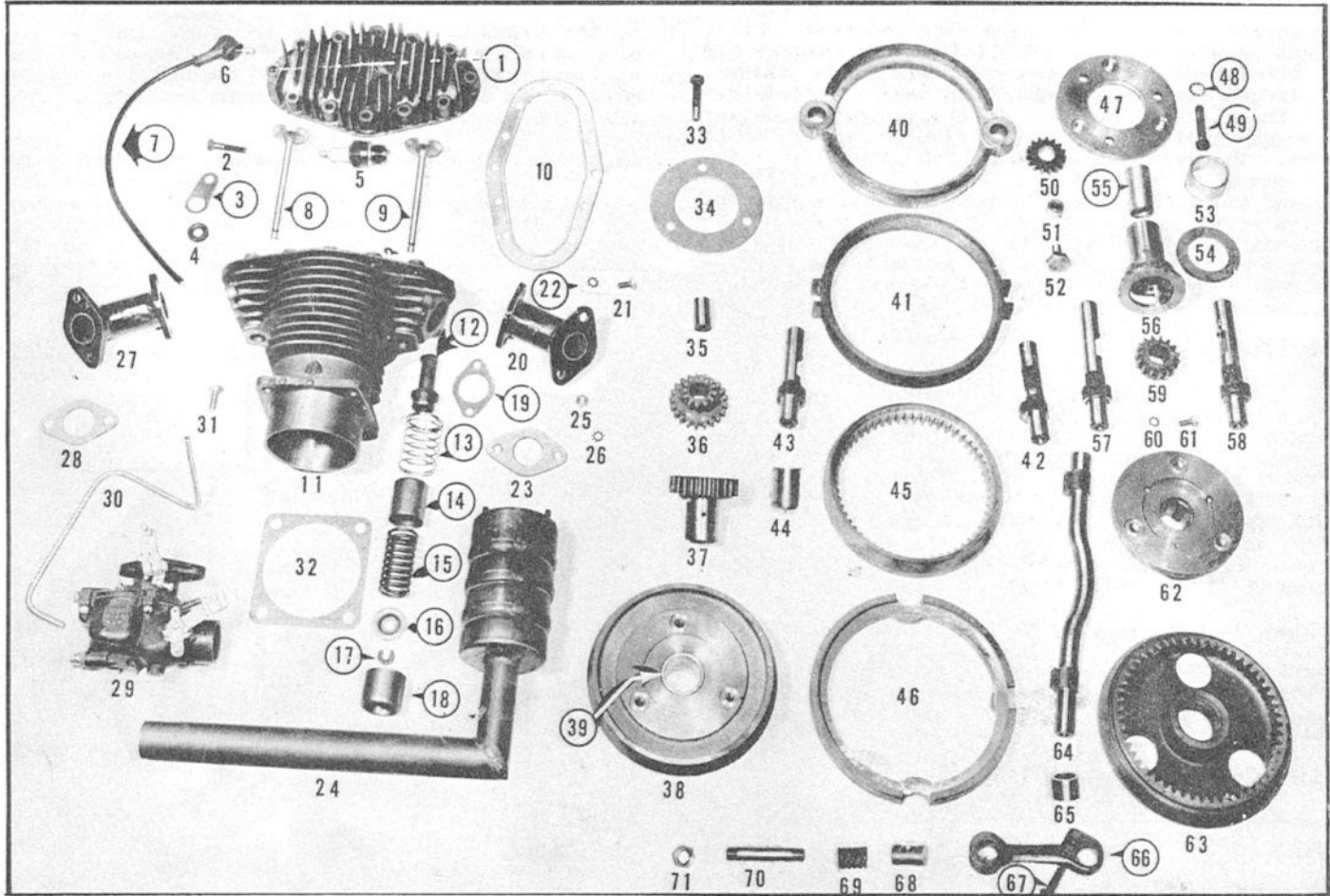

PHOTO NO.	PART NO.	DESCRIPTION	PRICE	PHOTO NO.	PART NO.	DESCRIPTION	PRICE
1	5734	Cylinder Head	6.58	37	L 511	Sun Gear	4.70
2	154-S	Cylinder Head Bolt	.04	38	L 506	Rear Pin Plate	3.63
3	L 826	Cable Bracket	.11	39	L 536	Rear Pin Plate Bushing	.44
4	L 827	Rubber Grommet	.03	40	L 502	Rear Spacer	3.77
5	1709	Spark Plug	.66	41	L 503	Clutch Cup	2.75
6	1726	Spark Plug Nipple	.22	42	L 711-R	Clutch Slide Rod, Short	1.45
7	1731	Magneto Cable, Complete	.33	43	L 711-L	Clutch Slide Rod, Short	1.45
8	L 311-N	Valve, Intake	.66	44	L 714	Slide Rod Bushing	.39
9	L 311-X	Valve, Exhaust	.77	45	L 501	Internal Gear	3.10
10	5735	Cylinder Head Gasket	.53	46	L 508	Gear Cup	2.71
11	5733	Cylinder	18.54	47	L 539	Front Pin Spacer	2.40
12	5737	Valve Guide	.77	48	305-W	Spacer Lock Washer	.01
13	L 318	Sleeve Spring	.14	49	L 516-R	Spacer Bolt, Right Hand	.15
14	L 315	Upper Spring Sleeve	.20	50	L 540	Reverse Idler	1.17
15	L 312	Valve Spring	.11	51	L 541	Reverse Idler Bushing	.12
16	5741	Valve Spring Cap	.11	52	L 542	Reverse Idler Bolt	.11
17	5742	Valve Spring Cap Key	.06	53	L 532	Quill Bearing	.47
18	L 316	Lower Spring Sleeve	.20	54	L 520	Front Thrust Plate	.53
19	L 407-B	Manifold Gasket	.03	55	L 546	Pinion Shaft Bearing	.24
20&27	L 301-A	Manifold, Intake and Exhaust	1.31	56	L 536	Pin Plate Quill	3.03
21	164-S	Manifold Bolt	.02	57	L 710-L	Clutch Slide Rod, Long	1.55
22	303-W	Manifold Bolt Lock Washer	.01	58	L 710-R	Clutch Slide Rod, Long	1.55
23	L 301-M	Muffler Gasket	.04	59	L 510	Sun Pinion	1.40
24	L 816	Muffler	3.85	60	303-W	Quill Securing Bolt Washer	.01
25	202-N	Muffler Securing Nut	.02	61	191-S	Quill Securing Bolt	.02
26	303-W	Muffler Sec. Nut Lock Washer	.01	62	L 505	Front Pin Plate	2.92
28	L 301-B	Zenith Carburetor Gasket	.04	63	L 537&8	Reverse Cone Assembly	6.97
29	L 806-Z	Carburetor-Zenith	12.29	64	L 712	Clutch Actuating Shaft	2.27
30	L 706	Gas Tube (Carburetor)	.17	65	L 713	Actuating Shaft Bushing	.19
31	126-S	Carburetor Bolt	.04	66	L 715	Actuating Shaft Lever	1.02
32	L 317	Cylinder Bottom Gasket	.04	67	154-S	Actuating Lever Clamp Bolt	.03
33	L 516-L	Spacer Bolt, Left Hand	.15	68	L 723	Clutch Rod Pivot	.24
NS	305-WL	Spacer Lock Washer, Left Hand	.02	69	L 729	Clutch Spring	.11
34	L 515	Pin Spacer	.33	70	L 730	Spring Sleeve	.24
35	L 514	Orbit Gear Pin	.19	71	210-N	Clutch Spring Sleeve Nut	.03
36	L 513	Orbit Gear	2.46	NS	L 534	Sun Gear Bushing	.18

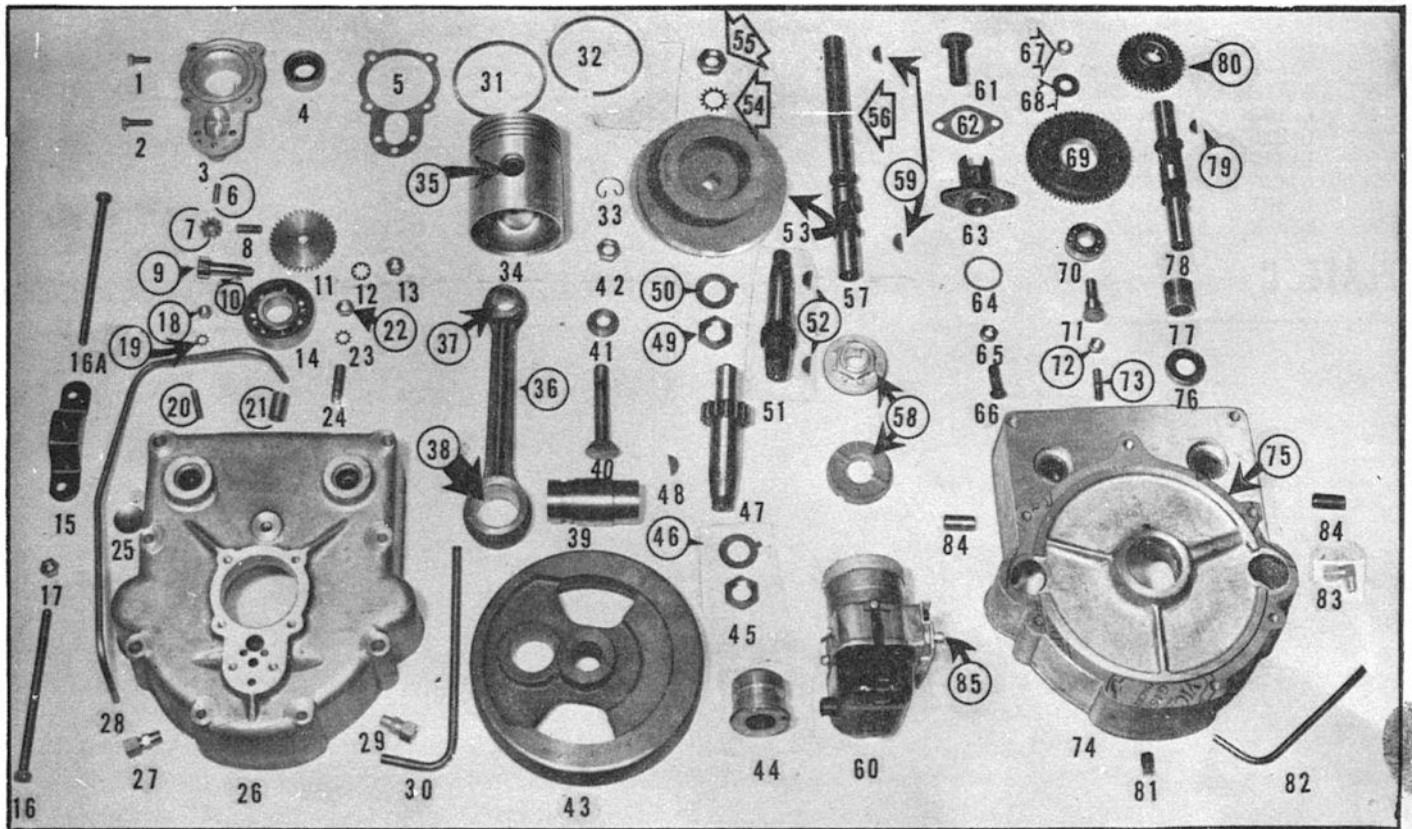

PHOTO NO.	PART NO.	DESCRIPTION	PRICE	PHOTO NO.	PART NO.	DESCRIPTION	PRICE
1	164-S	Bearing Cap Bolt Short	.02			Piston .025 With Pin	4.95
2	108-S	Bearing Cap Bolt Long	.07			Piston .030 With Pin	4.95
3	L 103	Bearing And Pump Cap	2.75	NS	802-A	Drive Pinion Shaft Set Screw	.10
4	L 126-A	Bearing Cap Double Seal	.77	34	LH 543	Piston Pin	.91
5	L 125	Bearing Cap Gasket	.02	36	L 306	Connecting Rod Complete	3.50
6	L 124	Bearing Cap Dowell	.04	37	L 306-A	Connecting Rod Bushing Small	.36
7	L 422	Oil Pump Idle Gear	.77	38	L 306-B	Connecting Rod Bushing Large	.72
8	L 423	Idle Gear Stud	.10	39	L 105	Crank Pin	2.22
9	L 421	Oil Pump Master Gear	1.94	40	L 106	Spreader Bolt	.60
10	507-K	Oil Pump Master Gear Key	.02	41	L 107	Spreader Bolt Washer	.31
11	L 419-A	Oil Pump Drive Gear	1.21	42	210-N	Spreader Bolt Nut	.03
12	305-W	Oil Pump Master Gear Lk. Wshr.	.01	43	L 104	Fly Wheel	4.84
13	215-N	Oil Pump Master Gear Nut	.02	44	L 114	Drive Pinion Bearing	1.65
14	L 115	Timing Pinion Bearing	3.09	45	L 112	Fly Wheel Nut	.11
15	L 224	Fan Housing Bracket	.50	46	L 113	Fly Wheel Nut Lock	.04
16	L 116	Crank Case Bolt, Long	.14	47	L 109	Drive Pinion Shaft	4.26
16-A	L 117	Crank Case Bolt, Short	.14	48	504-K	Drive Pinion Shaft Key	.02
17	205-N	Fan Housing Bolt Nut	.03	49	L 112	Fly Wheel Nut	.11
18	202-N	Plunger Guide Stud Nut	.02	50	L 113	Fly Wheel Nut Lock	.04
19	303-W	Plunger Guide Lock Washer	.01	51	L 110	Timing Pinion Shaft	3.39
20	L 405	Plunger Guide Stud	.10	52	504-K	Fly Wheel Key	.02
21	L 420-A	Oil Pump Bearing Bushing	.25	53	5745	Fan Drive Pulley	5.11
22	206-N	Cylinder Stud Bolt Nut	.02	54	309-W	Fan Drive Pulley Nut Lock	.02
23	305-W	Cylinder Stud Bolt Lock Washer	.01	55	218-N	Fan Drive Pulley Nut	.08
24	L 303	Cylinder Stud Bolt	.10	56	L 810	Magneto Shaft Extension	.54
25	L 411	Expansion Plug	.08	57	L 402	Exhaust Cam Shaft	1.87
26*	L 101	Outer Crank case	14.85	58	L 809	Magneto Coupling Complete	2.73
27	L 707	Pump Discharge Connection	.15			Magneto Fiber Coupling	1.50
28	L 813-B	Pump Discharge Line	.17	59	503-K	Magneto Shaft Extension Key (Also Exhaust Cam Shaft Key)	.02
29	L 814-A	Pump Supply Connection	.28	60	L 808	Magneto	28.14
30	L 813-A	Pump Supply Line	.17	61	L 404	Valve Plunger	.77
31	LH 546	Oil Rings (Repairs) (o.s.)	.32	62	L 407-A	Valve Plunger Gasket	.03
		Oil Rings (Std.)	.32	63	L 403	Valve Plunger Guide	1.37
32	LH 547	Compression Ring (Repairs)(o.s.)	.32	64	L 319	Sleeve Gasket	.03
		Compression Ring (Std.)	.32	65	L 409	Tappett Lock Nut	.08
33		Piston Pin Lock	.01	66	L 408	Tappett Screws	.11
35	LH 544	Piston Std. With Pin	4.95	67	220-N	Bearing Stud Nut	.02
		Piston .005 With Pin	4.95	68	403-W	Bearing Stud Nut Washer	.01
		Piston .010 With Pin	4.95	NS	803-A	Inner Crank Case Set Screw	.10
		Piston .015 With Pin	4.95				
		Piston .020 With Pin	4.95				

(continued top of next page)

PHOTO NO.	PART NO.	DESCRIPTION	PRICE	PHOTO NO.	PART NO.	DESCRIPTION	PRICE
69	L 415	Idler Gear	2.18	80	L 413	Cam Shaft Gear	1.02
70	L 416	Idler Gear Bearing	1.49	81	701-P	Crank Case Drain Plug	.05
71	L 417	Bearing Stud	.29	82	L 813-C	Motor Supply Line	.17
72	215-N	Crank Case Stud Nut	.02	83	L 814-H	90° Oil Line Elbow	.25
73	L 118	Crank Case Stud Bolt	.10	NS	L 814-E	Nipple	.14
74*	L 102	Inner Crank Case	13.75	84	L 120	Crank Case Dowell	.15
75	L 210	Chassis Rear Gasket	.08	85	190-S	Magneto Bolt	.04
76	L 412	Cam Shaft Oil Seal	.47	NS	5784	Drive Pulley Pin	.06
77	L 410	Cam Shaft Bearing Bushing	.24				
78	L 401	Intake Cam Shaft	1.93				
79	503-K	Cam Shaft Gear Key	.02				

* Inner and Outer Crankcase Assembly sold as a unit. Total price: \$28.60

PLATE C

Chassis, Advance Casting & Oil Filter Assembly

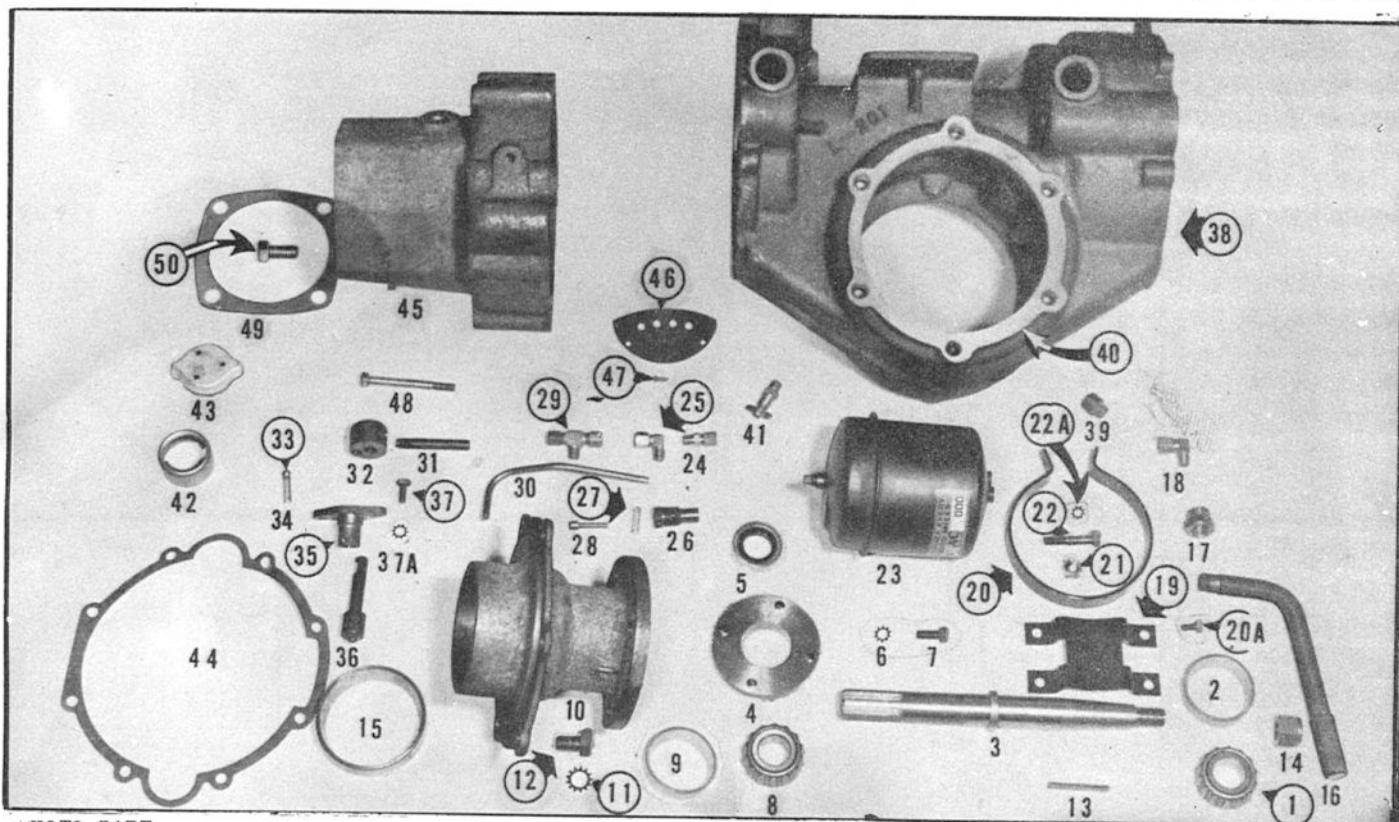

PHOTO NO.	PART NO.	DESCRIPTION	PRICE	PHOTO NO.	PART NO.	DESCRIPTION	PRICE
1&8	L 610	Axle Bearing (Cont)	1.64	30	L 813-C	Motor Supply Line	.17
2&9		Axle Bearing (Cup)	1.08	31	L 732	Shipper Shaft Lever	.10
3	L 611	Axle	2.48	32	L 733	Locator Body	.53
4	L 204-A	Bearing Cap	.87	33	1809	Locator Ball	.02
5	L 221	Bearing Cap Oil Seal, Double	.91	34	L 815-D	Locator Spring .025"	.11
6	304-W	Bearing Cap Lock Washer	.01	35	L 734	Shipper Shaft Guide	.87
7	126-S	Bearing Cap Bolt	.04	36	L 545	Shipper Shaft	1.35
10	L 203-A	Axle Housing	9.39	37	164-S	Shipper Shaft Guide Bolt	.02
11	308-W	Axle Housing Bolt Lock Washer	.01	37-A	303-W	Shipper Shaft Blt. Lk. Wshr.	.01
12	122-S	Axle Housing Bolt	.08	38	L 201	Chassis Casting	29.72
13	L 615	Axle Key	.04	39	705-P	Chassis Drain Plug	.06
14	219-N	Axle Nut	.18	L 219	(.005) Bearing Cap Shim (ea.)	.09	
15	L 609	Differential Bearing (Cup)	1.59		(Set of 6)	.54	
16	L 822	Oil Strainer Body	.58		(.020) Bearing Cap Shim (ea.)	.12	
17	L 823	Oil Strainer Nut	.36		(Set of 2)	.24	
18	L 814-F	Pump Supply Elbow	.35	40	L 220	(.005) Axle Housing Shim (ea.)	.17
19	L 828	Filter Bracket	.53		(Set of 6)	1.02	
20	L 829	Oil Filter Mounting Band	.20		(.020) Axle Housing Shim (ea.)	.22	
20-A	165-S	Filter Bracket Bolt	.02		(Set of 2)	.44	
21	201-N	Filter Band Nut	.02	41	L 214	Oil Level Try Cock	.39
22	149-S	Filter Band Bolt	.06	42	L 211	Chassis Oil Filter Neck	.15
22-A	303-W	Filter Band Washer	.01	43	L 212	Chassis Oil Filter Cap	.62
23	L 812	Oil Filter	2.75	44	L 209	Chassis Front Gasket	.08
24	L 707	Tube Connector	.15	45	L 202	Advance Casting	8.09
25	L 814-D	Motor Supply Elbow	.27	46	L 202-A	Baffle Plate	.87
26	L 815-A	Relief Valve Body	.53	47		Baffle Plate Rivet	.01
27	L 815-C	Relief Valve Spring	.09	48	L 207	Advance Casting Bolt	.12
28	L 815-B	Relief Valve	.40	49	5056	Attachment Gasket	.07
29	L 814-C	Discharge Line Tee	.38	50	160-S	Attachment Bolt	.08

PLATE D

Internal Chassis & Worm Gear Assembly

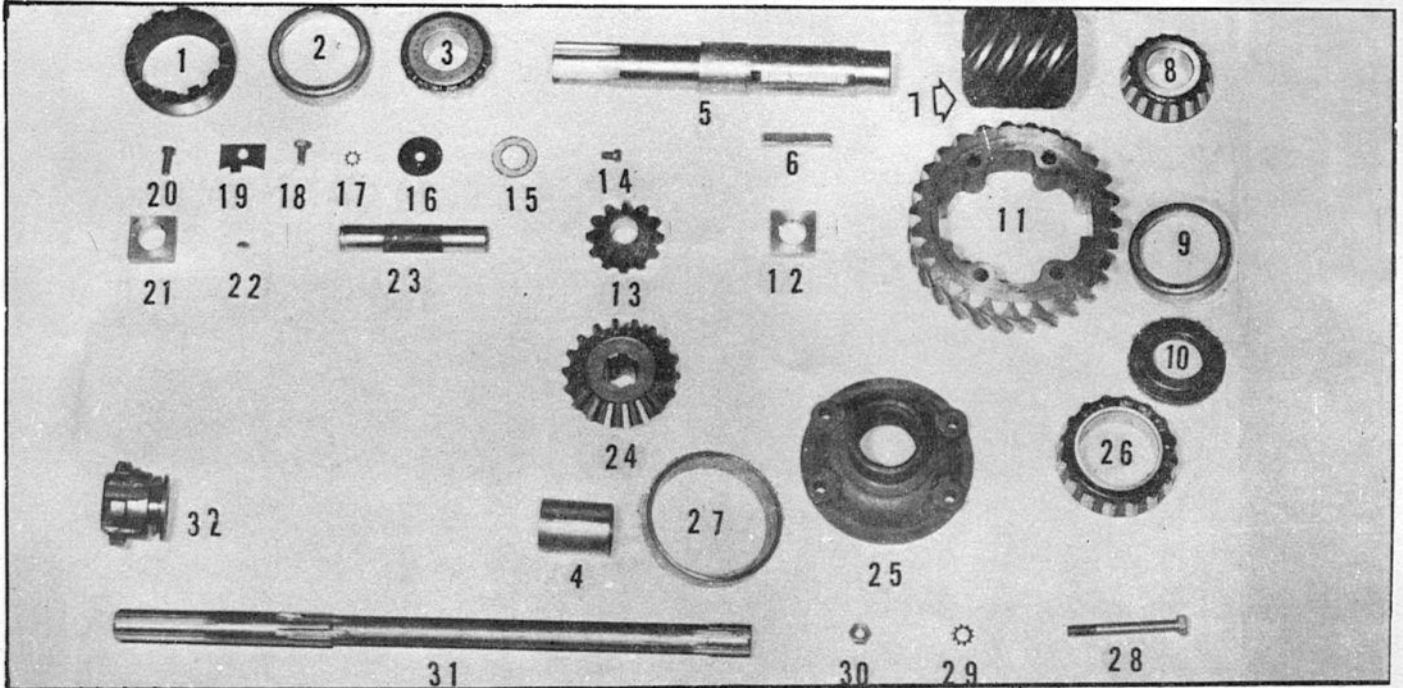

PHOTO NO.	PART NO.	DESCRIPTION	PRICE	PHOTO NO.	PART NO.	DESCRIPTION	PRICE
1	L 507	Bearing Adjusting Nut	1.21	19	L 523	Adjusting Nut Lock	.04
2&9	L 522	Worm Shaft Bearing (Cone)	2.01	20	107-S	Gear Cup Screw	.06
3&8		Worm Shaft Bearing (Cup)	1.19	NS	303-W	Gear Cup Screw Lock Washer	.01
4	L 547	Worm Shaft Spacer	.30	21	L 607	Driving Block	.83
5	L 521	Worm Shaft	3.58	22	501-K	Pinion Pin Key	.02
6	L 608	Worm Key	.04	23	L 605	Pinion Pin	.77
7	L 601	Worm	9.80	24	L 604	Bevel Gear	4.49
10	L 519	Rear Thrust Plate	.53	25	L 205	Differential Housing	1.94
11	L 602	Worm Gear	20.44	26	L 609	Differential Bearing (Cone)	2.97
12	L 607-K	Driving Block (With Keyway)	.91	27		Differential Bearing (Cup)	1.59
13	L 603	Bevel Pinion	2.65	28	L 206	Differential Housing Bolt	.12
14	107-S	Lock Screw	.06	29	304-W	Differential Housing Blt. Lk. Washer	.01
15	L 735	Clutch Act. Shaft Oil Seal	.03	30	204-N	Differential Housing Nut	.02
16	L 736	Oil Seal Washer	.03	31	L 543	Pinion Shaft	3.03
17	303-W	Actuating Shaft Lock Washer	.01	32	L 544	Clutch Dog	3.39
18	165-S	Actuating Shaft Securing Screw	.02				

PLATE E

Fan Assembly

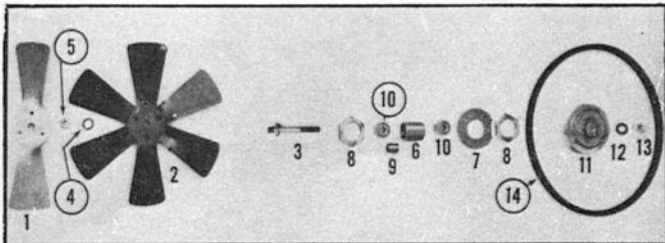

PHOTO NO.	PART NO.	DESCRIPTION	PRICE
1	L 805	Fan Blade	.58
2		Fan Blade Assembly Complete	1.94
NS	5138	Fan Blade Rivet	.01
3	5137	Fan Shaft	.44
4	305-W	Fan Nut Lock Washer	.01
5	206-N	Fan Securing Nut	.02
6	5133	Fan Bearing Race Retainer	1.05
7	L 830	Fan Retainer Adjusting Washer	.17
8	5134	Fan Bearing Lock Nut	.25
9	5165	Fan Bearing Spacer	.06
10	5139	Fan Ball Bearing	1.42
11	L 802	Fan Pulley	1.11
12	401-W	Fan Pulley Jam Nut Washer	.01
13	204-N	Fan Pulley Jam Nut	.02
14	5163	Fan Belt	.93

PLATE E-1

Return U Assembly

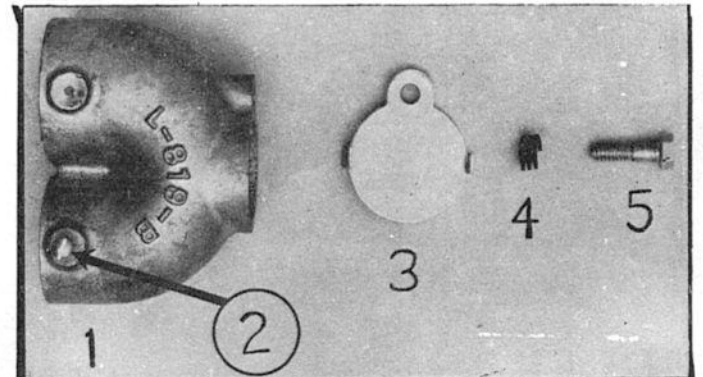

PHOTO NO.	PART NO.	DESCRIPTION	PRICE
1	L 819-B	Manifold Return Casting	1.45
2	101-S	Return U Securing Screw	.02
3	L 819-B1	Manifold Return Casting Vent Cover	.05
4	L 819-B2	Manifold Return Casting Vent Cover Spring	.02
5	L 819-B3	Manifold Return Casting Vent Cover Screw	.03

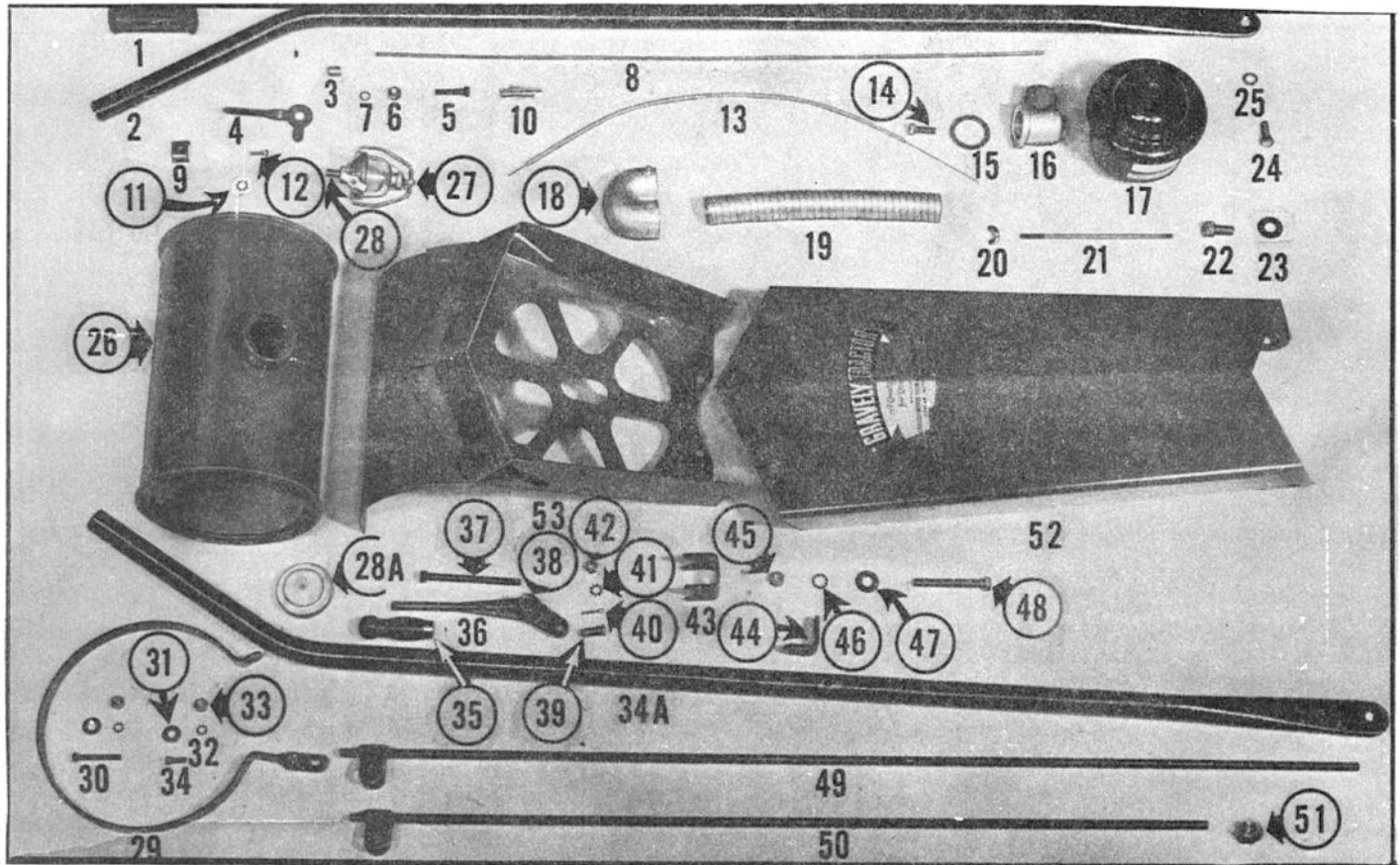

PHOTO NO.	PART NO.	DESCRIPTION	PRICE
1	5125	Driving Handle Grip	.55
2	L 724-L	Driving Handle, Left	1.90
3	L 741	Throttle Lever Hub	.06
4	L 740	Throttle Lever	.19
5	154-S	Throttle Lever Pivot Bolt	.04
6	214-N	Pivot Bolt Nut	.02
7	401-W	Pivot Bolt Washer	.01
8	L 737	Throttle Wire	.08
9	L 739	Throttle Guide Clamp Washer	.08
10	L 738	Throttle Wire Guide	.02
11		Not Used	
12	102-S	Guide Clamp Securing Screw	.02
13	L 729-A	Choke Wire	.11
	L 729-B	Choke Wire Guide	.13
14	101-S	Air Filter Bracket Lock Screw	
15	L 819-G	Gasket	.08
16	L 819-C	Air Filter Bracket	1.69
17	L 817-A	Donaldson Oil Bath Air Cleaner	4.24
18		See Plate E-1	1.45
19	L 819	Air Filter Manifold	.44
20	L 819-F	Wing Nut	.07
21	L 819-E	Air Filter Bolt	.10
22	L 819-D	Air Filter Bracket Bolt	.10
23	L 821	Hood Spacer	.04
24	111-S	Driving Handle Securing Bolt	.05
25	305-W	Driving Handle Sec. Bolt. Lk.Wshr.	.01
26	L 701	Tank	6.00
27	L 705	Gas Strainer Complete	1.38

PHOTO NO.	PART NO.	DESCRIPTION	PRICE
28	L 814-E	Gas Filter Nipple	.14
28-A	2505	Tank Cap	.35
29	5164	Tank Band	.29
30	149-S	Tank Band Bolt Long	.06
31	401-W	Tank Band Bolt Washer	.01
32	303-W	Tank Band Bolt Lock Washer	.01
33	201-N	Tank Band Bolt Nut	.02
34	107-S	Tank Band Bolt, Short	.06
34-A	L 724-R	Driving Handle, Right	1.90
35	5167	Hand Lever Grip	.20
36	L 716	Clutch Hand Lever	.63
NS	L 716	Speed Selector Lever	.63
37	L 718	Hand Lever Pivot Bolt	.17
38	L 717	Hand Lever Pivot	.53
39	L 722	Clutch Rod Clevis Pin	.15
40	602-C	Clevis Cotter Pin	.01
41	401-W	Hand Lever Pivot Bolt Washer	.01
42	204-N	Hand Lever Pivot Bolt Nut	.02
43	L 728	Driving Handle Bracket	.10
44	L 742	Clutch Rod Brace	.15
45	205-N	Drive Handle Bracket Bolt Nut	.03
46	305-W	Drive Handle Brkt.Bolt Lk.Wshr.	.01
47	403-W	Drive Handle Brkt.Blt.Flat Wshr.	.01
48	131-S	Drive Handle Rear Bolt	.09
49	L 720-L	Clutch Rod, Long	.86
50	L 720-S	Clutch Rod, Short	.83
51	220-N	Clutch Rod Adjusting Nut	.02
52	L 820	Hood	1.65
53	L 222	Fan Housing	3.49

PLATE F-1 Safety Clutch & Starting Strap

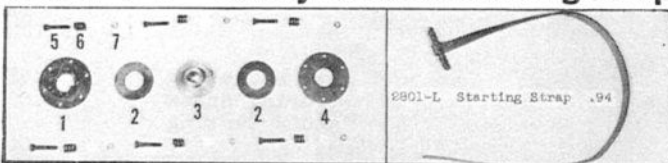
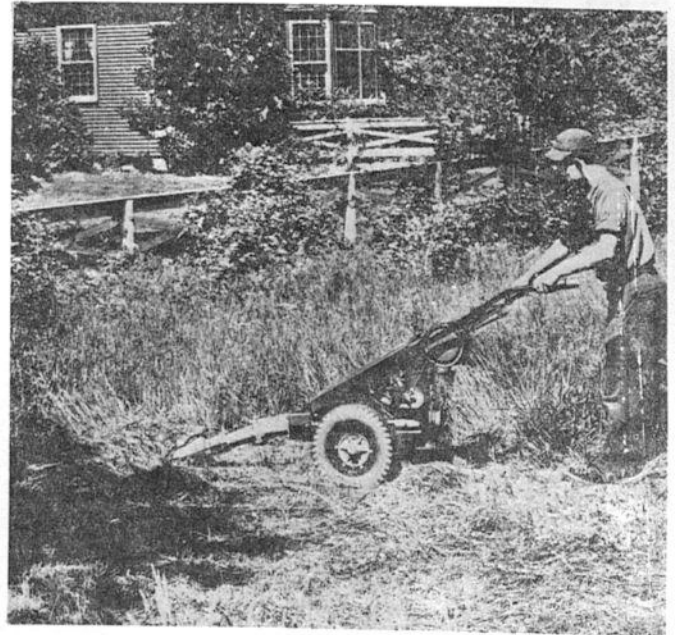
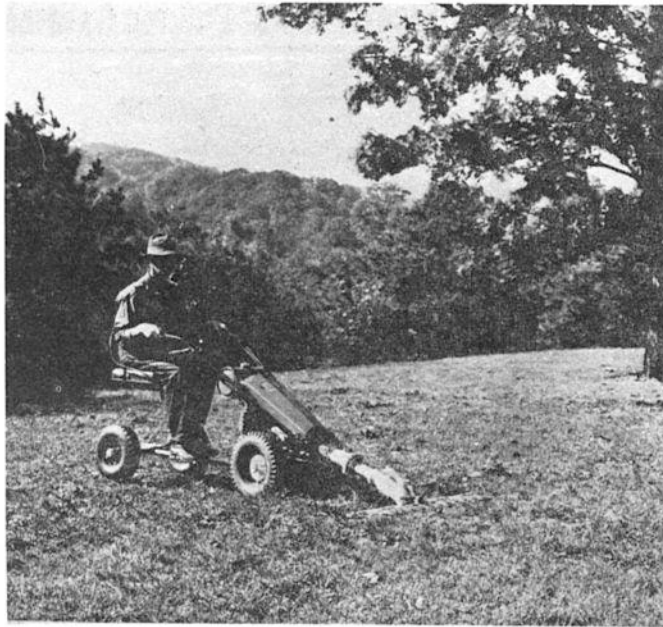

PHOTO NO.	PART NO.	DESCRIPTION	PRICE
1	SC 30	Dog Plate	4.40
2	SC 34	Friction Washer	.21

PHOTO NO.	PART NO.	DESCRIPTION	PRICE
3	SC 33	Drive Plate Keyway	1.16
NS	SC 33-S	Drive Plate, Spline, Rotary Mower & Power Brush	1.16
4	SC 32	Back Plate	.61
5	SC 37	Spring Bolt	.12
6	SC 35	Spring	.12
7	215-N	Spring Bolt Nut	.02
NS	232-N	Spring Bolt Lock Nut, Sickle Mower Only	.10



SICKLE MOWER

LUBRICATION: DON'T FORGET TO OIL THE MOWER BEFORE USING! NOTICE THE TWO OIL PLUGS FOUND ON TOP OF THE GEAR HOUSING OF THE DRIVE MECHANISM. REMOVE THE LOWER PLUG, THE ONE TOWARD THE SICKLE BAR, AND FILL WITH ABOUT ONE-HALF PINT OF MOBILUBE C (SAE 140 GEAR OIL) OR ITS EQUIVALENT. ALWAYS KEEP WELL LUBRICATED. NEVER USE HEAVY GREASE. IF GEAR OIL IS NOT AVAILABLE USE THE HEAVIEST GRADE OF MOTOR OIL OBTAINABLE. REMOVE THE UPPER PLUG, THE ONE NEXT TO THE TRACTOR, AND CHECK THIS ALSO. IT SHOULD BE ABOUT HALF FULL OF MOBILGREASE NO. 2 OR ITS EQUIVALENT.

Skids can be purchased from your dealer. For most of your work you will not find it necessary to use these. With them you can further regulate the cut. If four are used put directly under the first and fifth guard from either end. The Guard Bolts are removed and the Skid Bolts put in the vacant holes, using the same Guard Nuts. One small Adjusting Spacer is furnished with each Skid. One or more of these can be used, and which further regulates the depth of height of the cut.

A patented and highly important feature found on the GRAVELY Mower is the SWIVEL ACTION OF THE CUTTER BAR. On the upper part of the two Crank Housing castings you will find four nuts and bolts. The first two on either side, and closer to the tractor proper, effect the swivel. With these nuts tight, the bar is held rigid. But, loosen them and you will have the SWIVEL ACTION. For mowing level ground the bar swivel can be tight. But for hillsides it should be loosened to allow the bar to follow the slope of the ground while the tractor remains upright. DON'T HAVE THE SWIVEL LOOSE ENOUGH TO TURN WITHOUT SOME PRESSURE. It should be just tight enough to hold its position until lowered, when its own weight should cause it to tilt according to the slope of the ground.

Best results are secured by operating at an easy walking speed. DON'T RACE YOUR MOTOR. If you get into grass that you cannot cut without racing the motor, SHARPEN THE KNIVES. Racing is hard on the machine and makes you more likely to break something in case you hang in wire or anything that the knives won't cut. At a moderate speed you can cut from three to four acres per day, and if your motor does stall you will not do any damage beyond a nick in the knife.

SUGGESTIONS FOR SECURING THE BEST MOWING RESULTS

A SHARP SICKLE. Any kind of a dull, gapped sickle-bar will cut coarse weeds and bushes, but when you get into fine grass you will have trouble if your knives are dull. Keep them sharp. To remove the cutting knife complete to sharpen for instance, remove the Knife Bracket Screws and slip the blade out on either side. ALWAYS KEEP THESE SCREWS REAL TIGHT. If they are even a little loose there is danger of stripping the threads. Sharpen the knives often. They will hold an edge longer, will not nick so easily and will cut equally as well if ground at an angle of 45 degrees, or about the same as scissors are ground. (A small Hand Sickle Grinder with a proper curved wheel, will pay for itself time and again in better mowing results).

See that the knife bar is straight and the points of the knives are in line so that the Sickle-bar will lay flat on the guards.

Keep the guards in alignment. If one guard gets knocked up and the other down it will not cut fine grass. Use a light hammer and knock the guards up or down until the knives on the Sickle-bar lay flat in contact with the shearing edges of the guards. Make sure that all the guard bolts are drawn tight.

Adjust the clips that hold the sickle-bar closely, but do not allow them to bind. The knife should slide back and forth easily with the pressure of finger and thumb. It is not necessary to lubricate the knife as the grass will furnish lubrication, but a few drops of machine oil on the sections will help to prevent rust and sometimes make for easier running.

If these few directions are followed your Mower will last almost indefinitely. Keep out of wire, iron, rocks, tin cans, and so on. If the GRAVELY Mower is kept properly adjusted and sharpened it does its work so easily that mowing becomes a pleasure instead of one of the dreaded jobs. It will mow anything from wire grass to locust sprouts, and will do it cleaner, better and easier than any mowing machine built.

PLATE G

Sickle Mower Column Assembly

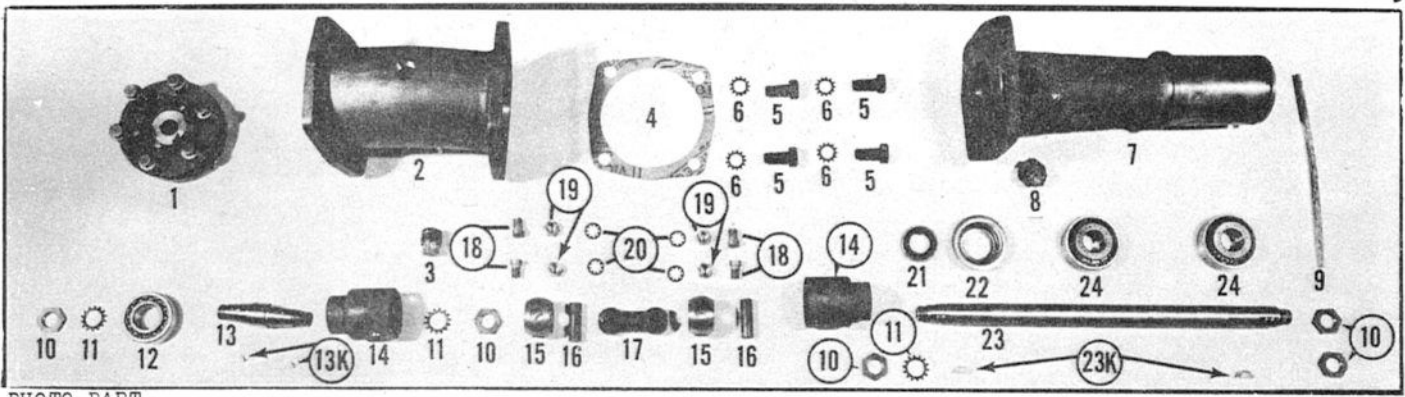

PHOTO NO.	PART NO.	DESCRIPTION	PRICE
1		Slip Clutch Complete	8.15
2	3197	Universal Housing	6.15
3	702-P	Universal Housing Plug	.06
4	5056	Universal Housing Gasket	.07
5	160-S	Universal Housing Conn. Bolt	.08
6	308-W	Universal Housing Conn. Lk.Wshr.	.01
7	3107	Drive Column	7.62
8	703-P	Drive Column Plug	.09
9	3173	Swivel Cork Seal	.03
10	1304	Crank Shaft And Stud Shaft Nut	.12
11	309-W	Stud Shaft Lock Washer (Also Crank Shaft Lk. Wshr.)	.02
12	3197-G	Stud Shaft Bearing	3.10
13	3197-F	Stud Shaft	1.44
13-K	504-K	Stud Shaft Key	.02
14	3197-A	Universal Cup	2.90
15	3197-B	Center Ring	1.32
16	3197-D	Pivot Pin	.46
17	3197-C	Link	1.23
18	3197-E	Pivot Stud	.12
19	231-N	Pivot Elastic Stop Nut	.12
20	305-W	Pivot Stud Lock Washer	.01
21	L 126	Oil Seal	.56
22	3151	Oil Seal Retainer	.04
23	3142-A	Crank Shaft	1.91
23-K	504-K	Crank Disc Key	.02
24	3147	Crank Shaft Bearing Assy. (Cone & Cup)	2.62

PLATE H

Sickle Mower Head Assembly

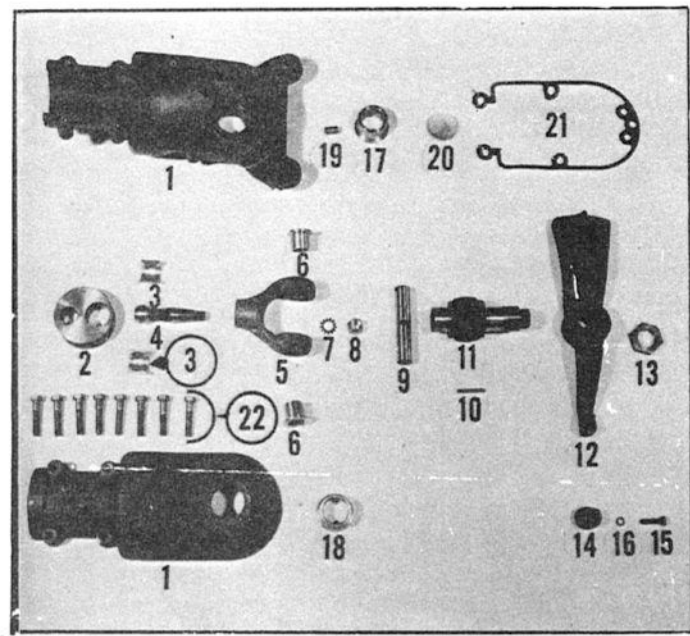

PHOTO NO.	PART NO.	DESCRIPTION	PRICE
1	3114 & 3115	Crank Housing Assy.	12.39
2	3143-A	Crank Disc	1.67
3	3145	Ball Stud Bearing	1.17
4	3144	Crank Yoke Ball Stud	2.44
5	3116	Crank Yoke	2.93
6	3178	Knuckle Pin Bearing	.35
7	308-W	Ball Stud Washer	.01
8	208-N	Ball Stud Nut	.03
9	3176	Crank Yoke Knuckle Pin	1.45
10	3177	Knuckle Pin Lock Rivet	.01
11	3179-S	Actuating Lever Shaft	4.35
12	3117-S	Knife Actuating Lever	3.09
13	3181	Actuating Lever Nut	.15
14	3182	Actuating Lever Wearing Tip	.97
15	3154	Wearing Tip Bolt	.05
16	303-W	Wearing Tip Lock Washer	.01
17	3180	Lever Shaft Bearing (Slotted)	.45
18	3180	Lever Shaft Bearing	.45
19	3184	Crank Housing Dowell	.04
20	3198	Crank Housing Expansion Plug	.06
21	3191	Crank Housing Gasket	.12
22	124-S	Crank Housing Bolt	.05
NS	305-W	Crank Housing Bolt Lock Washer	.01

PLATE I

Wheel Assembly

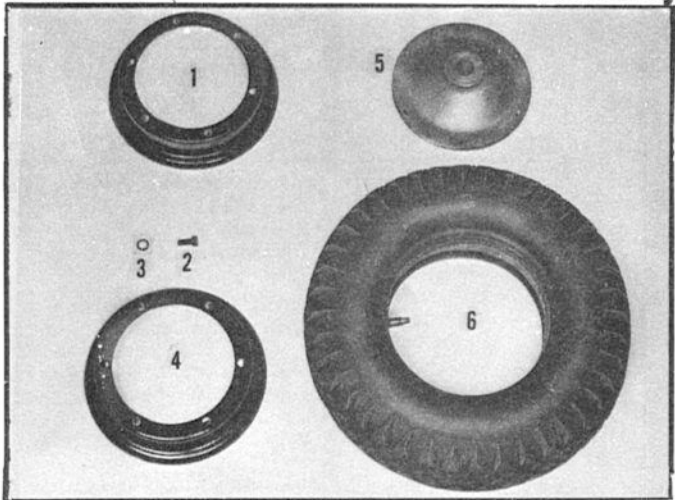

PHOTO NO.	PART NO.	DESCRIPTION	PRICE
1	L 616-A	Inner Wheel Disc	1.09
2	121-S	Hub Screw	.08
3	305-W	Hub Screw Lock Washer	.01
4	L 616-A	Outer Wheel Disc	1.09
5	L 614-B	Wheel Hub	3.41
6	L 616	Tire And Tube (Price on request)	

PLATE J

3 Inch Sickle Bar

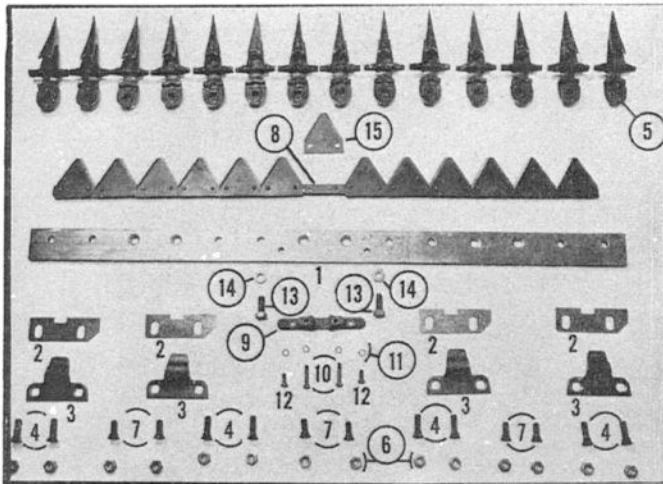

PHOTO NO.	PART NO.	DESCRIPTION	PRICE
1	3301	Guard Bar	3.30
2	3311	Wearing Plate	.19
3	3309	Knife Clip	.19
4	3304	Guard Bolt, Through Clip, Long	.06
5	3302	Guard	.62
6	3312	Guard Bolt Nut	.03
7	3303	Guard Bolt, Short	.06
8	3305	Knife Back	1.64
9	3510-B	Knife Drive Bracket 3"	1.23
10	M 514	Knife Drive Brkt. Bolt, Long	.06
11	233-N	Knife Drive Brkt. Lock Nut	.06
12	M 515	Knife Drive Brkt. Bolt, Short	.05
13	152-S	Guard Bar Securing Bolt	.09
14	211-N	Guard Bar Securing Bolt Nut	.05
15	3206	Knife Section, .09 Each, (Box of 25)	1.70
16	3206-A	Right Hand Section	ea. .09
17	3206-B	Center Section	ea. .09
18	3206-C	Left Hand Section	ea. .09
NS	3213	Skid Spacer	.08
NS	3306	Knife Complete With Bracket	4.24
NS	3307	Knife Rivets, .01 each, Per Lb.	.29
NS	3300	3" Sickle Bar Comp. With Brkt.	18.15
NS	3211	Skid	.20
NS	3212	Skid Bolt	.08
NS	3312	Skid Bolt Nut	.03
NS		Skid Complete	.39
		Ledger Plates, .09 ea. (Box of 25)	1.70
		Ledger Plate Rivets, .01 ea. (Per Lb.)	.29

PLATE K

2 Inch Sickle Bar

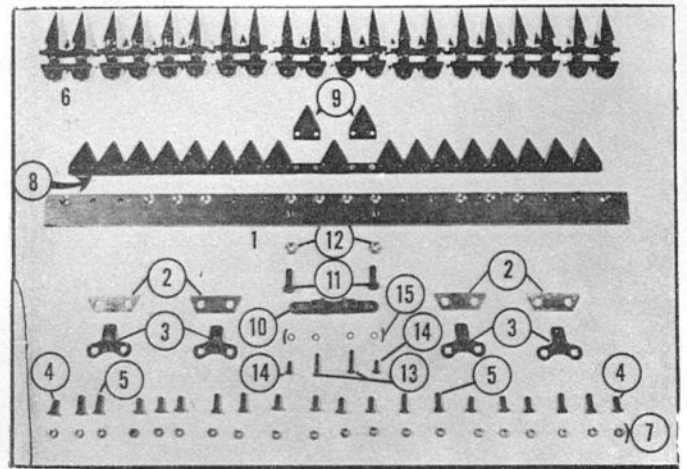
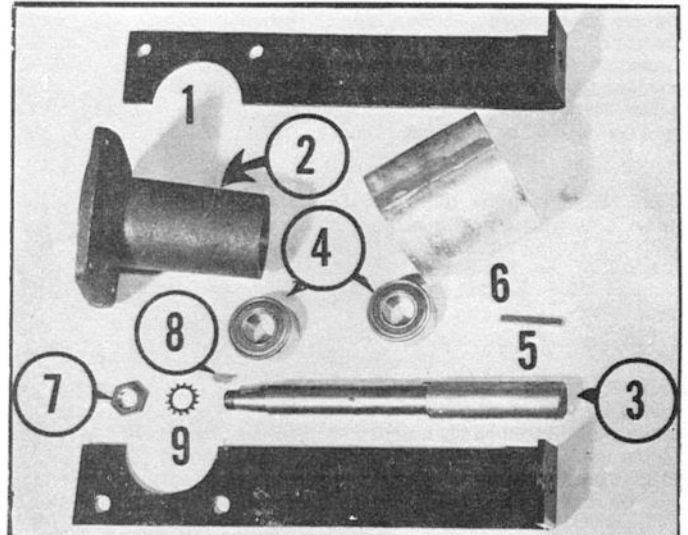

PHOTO NO.	PART NO.	DESCRIPTION	PRICE
1	3501	Guard Bar	3.30
2	3504	Wearing Plate	.19
3	3503	Clip	.19
4	147-S	Guard Bolt, Short	.06
5	3512-A	Guard Bolt, Long	.06
6	3502-A	Double Guard	.96
7	3509	Guard Bolt Nut	.04
8	3505	Knife Back	1.64
		Knife Sec. Each .09, (Box of 25) (All Sections shown except those indicated by 9)	1.70
9	3506-B	Bracket Section	ea. .09
10	3510-A	Knife Drive Bracket	1.23
11	160-S	Guard Bar Securing Bolt	.08
12		Not Used	
13	M 514	Knife Drive Brkt. Bolt, Long	.06
14	M 515	Knife Drive Brkt. Bolt, Short	.05
15	233-N	Knife Drive Brkt. Lock Nut	.06
NS	3500	2" Sickle Bar Complete	18.15
NS	3507	Knife, Complete with Bracket	4.24
NS	3511	Knife Rivet, Each .01, Per Lb.	.29
		2" Sickle Mower Guard Ledger plates (Ea. .09) Box of 25	1.70
		2" Sickle Mower Guard Ledger Plate Rivets (Ea. .01) Per Lb.	.29
		Skid Complete (With Spacer 3213 @ .08)	.39

PLATE L

Power Take Off

PHOTO NO.	PART NO.	DESCRIPTION	PRICE
1	A 339	Stands	1 Pr. 1.92
2	A 120	Bearing Housing	3.96
3	A 337	Take Off Shaft	2.52
4	A 338	Shaft Bearing	2.62
5	A 430	Pulley Key	.04
6		Pulley 4" x 4" Face	2.94
		Pulley 6" x 4" Face	5.67
		Pulley 8" x 4" Face	7.20
		Pulley 10" x 4" Face	8.97
		Pulley 12" x 4" Face	10.82
		Pulley 16" x 4" Face	14.95
7	1304	Shaft Nut	.12
8	504-K	Power Take Off Shaft Key	.02
9	309-W	Power Take Off Shaft Lock Washer	.02
NS	152-S	Mounting Screw	.09



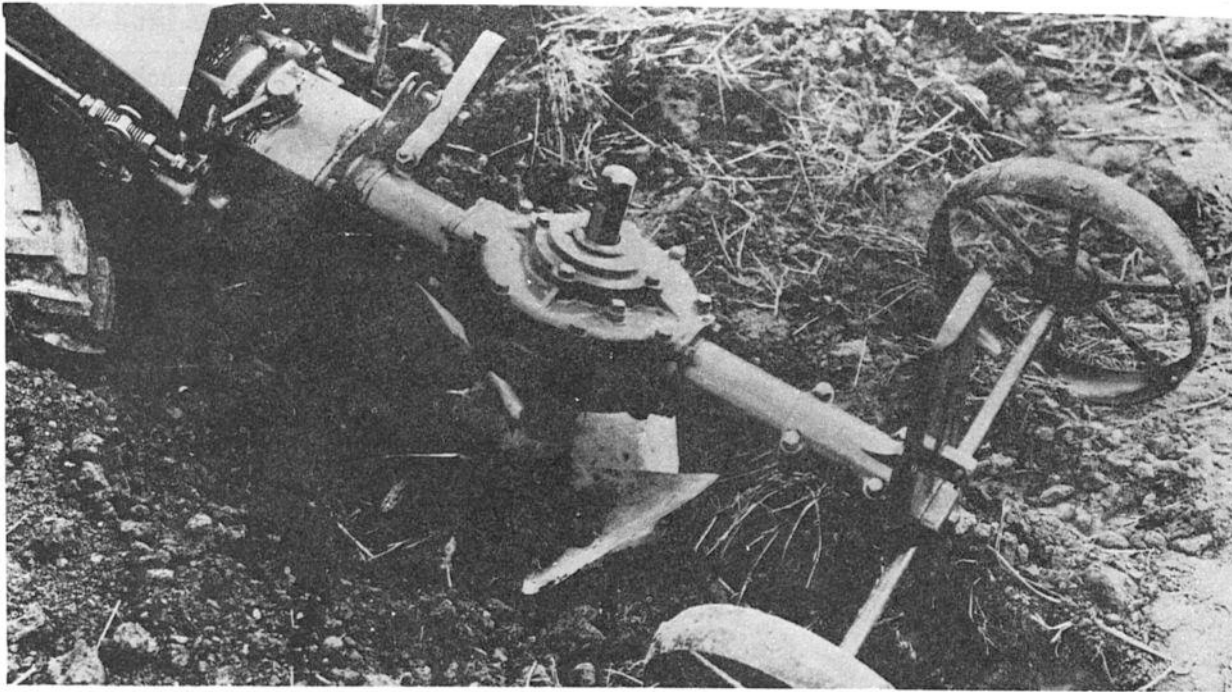

USING THE ROTARY PLOW

DEPTH OF CUT: Govern the depth of cut first by inserting the cotter pin into the Rotor Shaft. The higher up on the shaft you insert the pin the farther down will go the blades and the deeper the furrow. Then, make your final depth adjustment by sliding the wheel bracket clamp screw up or down on the wheel bracket. The lower you set it, the deeper you will plow.

WIDTH OF CUT: Adjust the width of the cut by the position of the wheel bracket in relation to the depth wheel that rides in the furrow. The closer over to the depth wheel you move the wheel bracket the narrower will be the cut. The wider the distance between the depth wheel and the wheel bracket the wider the cut will be.

SIDE DRAG: Sometimes there will seem to be an excessive side drag either to the right or left when plowing. This side drag is controlled by the angle of the Rotor Shaft. The more nearly perpendicular the Rotor Shaft, the greater is the tendency to the left. The more nearly horizontal, the greater tendency to the right. The angle of the Rotor Shaft is controlled by the sliding bracket clamp which is located on the casting next to where the plow fastens on to the tractor. After a few trials you will be able to quickly adjust the plow so that it will require little effort to plow a straight furrow.

DIRT SHIELD: The Dirt Shield is attached to the outer gear housing by the dirt shield braces. Remove the two outer bolts from the gear housing and attach the braces. By bending these braces, you can put the shield in a position to throw the dirt in any manner desired.

LUBRICATION: Notice the oil plug found on top of the gear housing of your plow. This is the only necessary lubrication point. For proper lubrication, you should first drain out the old oil. Then, fill with about one and one-half pints of MOBILUBE C (SAE 140 Gear Oil).

GEARED WHEELS: If, when using the tractor with the rubber-tired wheels, it does not have quite enough traction, or the speed is too fast (be sure to use it awhile before deciding this) it is possible to remove the rubber wheels and insert instead gear reduction wheels. These also have more weight, which means greater traction.

FLOWING: In plowing your ground, you run your furrows exactly the same as you would with a turn plow. The greatest difference will be that your ground is completely pulverized instead of just turned over with the hardest work yet to be done.

When using the Tractor with the Sickle Mower, you will quickly decide that it is the easiest machine to handle you have ever operated. However, in using the Rotary Plow, you might at first say just the opposite. But, take our word for it that after you achieve the best adjustments for the job to be done, and have become familiar with the plow, it is just as easy to use as the mower.

INSTRUCTIONS FOR MOUNTING GEARED WHEELS ON STANDARD TRACTOR

To remove the Standard Wheels, take off the Hub Cap, Wheel, Nut and Cotter Pin. Screw on Kicker furnished with the Wheel Set. Strike several hard blows with a medium heavy hammer until Wheel is loosened. After lifting off Wheel, install Pinion. Then, place completely assembled Geared Wheel on axle housing.

For the next step, take the four, one-half inch cap screws furnished with your wheel, and run them through from the back side of the Axle Housing into the Mounting Plate on your wheel. This will fasten the wheel on securely.

Should you wish to change the position of the wheels, it will be necessary for you to change the position of the axle housing on the Tractor Chassis.

If your Tractor has Rubber-tired Wheels, and you do not get quite enough traction, we can furnish you with a set of tire chains which will tend to increase the Traction. However, the rubber tires with chains are not equal in traction to the Geared Wheels.

PLATE M

Rotary Plow

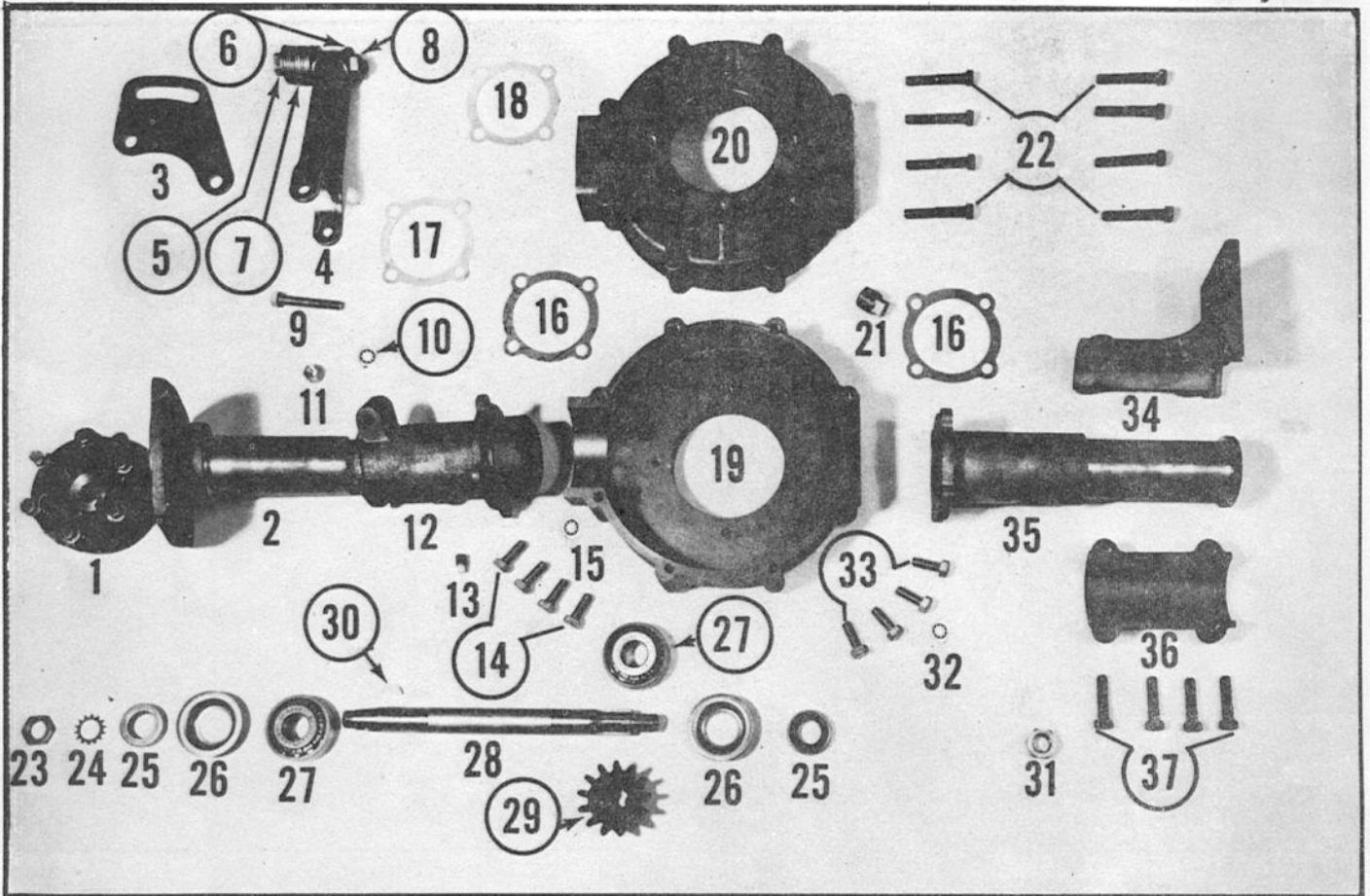

PHOTO NO.	PART NO.	DESCRIPTION	PRICE
1		Slip Clutch Complete	8.15
2	M 101	Drive Shaft Housing	4.03
3	A 301	Adjusting Bracket	.36
4	A 302	Adjusting Handle	.36
5	172-S	Adjusting Bolt	.14
6	413-W	Adjusting Spacer	.03
7	410-W	Adjusting Bolt Washer	.01
8	211-N	Adjusting Bolt Nut	.05
9	151-S	Adjusting Handle Bolt	.06
10	305-W	Adjusting Handle Bolt Lk. Wshr.	.01
11	205-N	Adjusting Handle Bolt Nut	.03
12	M 102	Swivel Casting	3.03
13	701-P	Swivel Casting Drain Plug	.05
14	112-S	Swivel Casting Securing Bolt	.05
15	305-W	Swivel Casting Sec. Bolt Lk. Wshr.	.01
16	M 326	Gear Housing Gasket	.05
17&18	M 139	Bearing Adjusting Shims .005 Bearing Adj. Shim	.07
		.020 Bearing Adj. Shim	.15
19&20	5330	Upper & Lower Gear Housing Set	8.83
21	702-P	Bevel Gear Housing Plug	.06
22	151-S	Gear Housing Bolt	.06
23	1304	Safety Clutch Nut	.12
24	309-W	Pinion Drive Shaft Lk. Wshr.	.02
25	L 126	Drive Shaft Oil Seal	.56
26	3151	Drive Shaft Oil Seal Retainer	.08
27	3147	Pinion Drive Shaft Bearing	2.62
28	M 308	Pinion Drive Shaft	1.21
29	5309-S	Bevel Pinion Gear	2.86
30	504-K	Bevel Pinion Gear Woodruff Key	.02
31	227-N	Pinion Drive Shaft Nut	.18
32	305-W	Gear Housing Ext. Bolt Lk. Wshr.	.01
33	112-S	Gear Housing Extension Bolt	.05
34	5326	Wheel Bracket Swivel	1.79
35	5331	Gear Housing Extension	4.83
36	5328	Wheel Bracket Cap	1.25
37	137-S	Wheel Bracket Swivel Bolt	.04

PLATE N

Rotary Plow

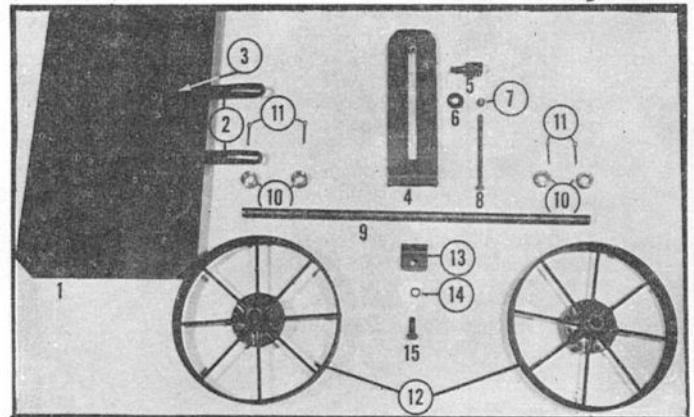

PHOTO NO.	PART NO.	DESCRIPTION	PRICE
1	5324	Dirt Shield	1.07
2	2703	Dirt Shield Brace	.19
3	121-S	Dirt Shield Brace Bolt	.04
NS	305-W	Brace Bolt Lock Washer	.01
NS	205-N	Dirt Shield Brace Bolt Nut	.03
4	5303	Wheel Bracket	1.98
6	410-W	Wheel Bracket Clamp Screw Wshr.	.01
5	5325	Wheel Bracket Clamp Complete	.40
7			
8			
9	5311	Depth Wheel Axle	1.09
10	A 374	Axle Thrust Collar	.19
11	603-C	Axle Thrust Collar Cotter Pin	.01
12	5327	Depth Wheel	2.46
13	5304	Axle Clamp	.55
14	308-W	Axle Clamp Bolt Lock Washer	.01
15	152-S	Axle Clamp Bolt	.09

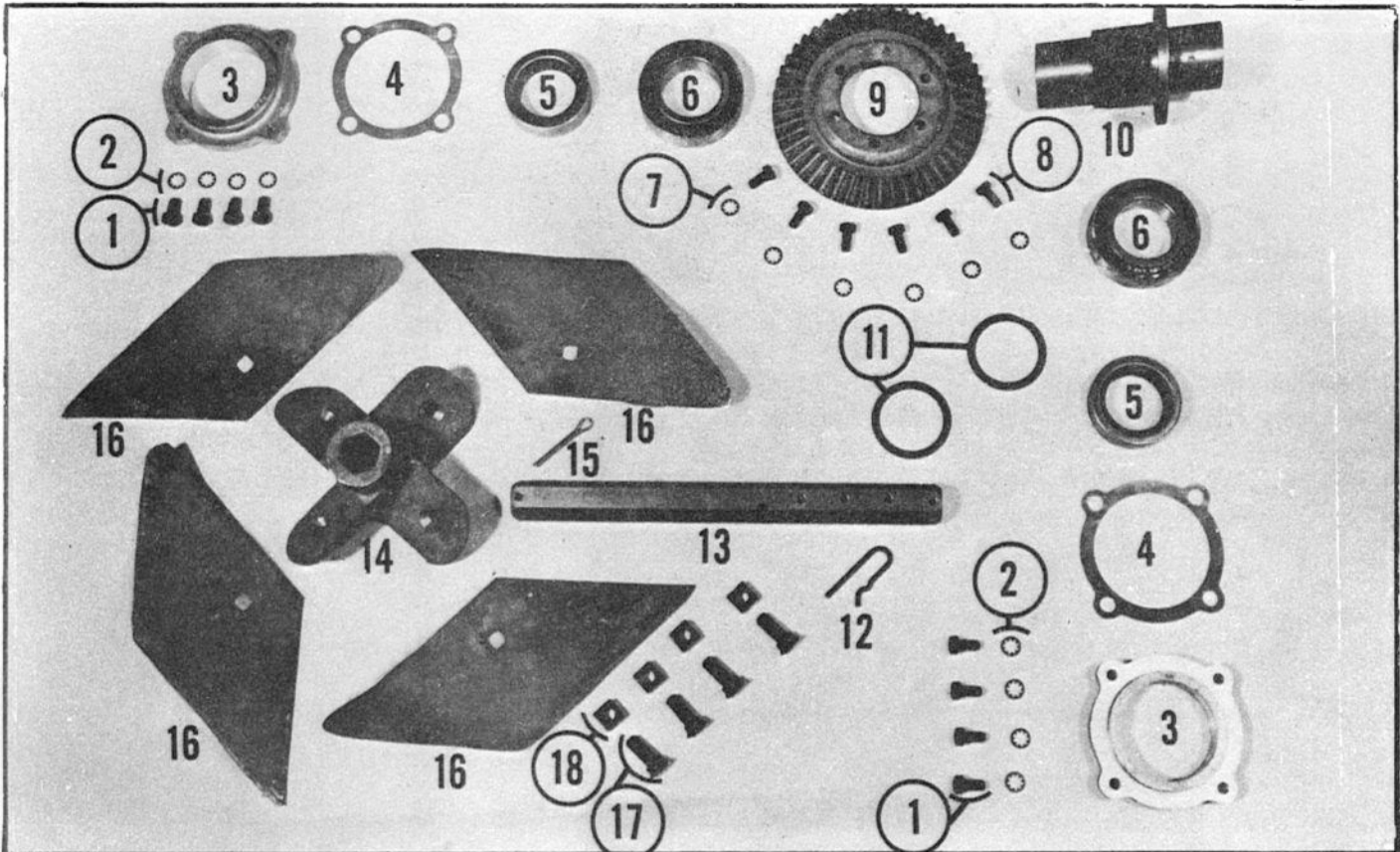

PHOTO NO.	PART NO.	DESCRIPTION	PRICE
1	121-S	Housing Bearing Cap Bolt	.04
2	305-W	Housing Bearing Cap Bolt.Lk.Wshr.	.01
3	5308	Housing Bearing Cap	1.96
4	5317	Bearing Adjustment Shims .005 Bearing Adjusting Shims .020 Bearing Adjusting Shims	.05 .25
5	5318-A	Gear Housing Oil Seal	1.39
6	2208	Bevel Gear Hub Bearing Comp.	5.21
7	305-W	Bevel Gear Lock Wash.r	.01
8	121-S	Bevel Gear Bolt	.04

9	5315	Bevel Gear	2.95
10	5306	Bevel Gear Hub	5.71
11	5413	Bevel Gear Hub Adjusting Shim	.05
12	5310-C	Rotor Axle Depth Adj. Pin	.06
13	5310	Rotor Axle (.05 per inch for each additional inch)	1.69
14	5312	Rotor Spider Hub	3.77
15	604-C	Rotor Axle Cotter Pin	.02
16	5322	Rotor Spade Cutter	1.21
17		1/2" x 1-1/2" No. 3 Plow Bolt	.08
18		1/2" x 1-1/2" No. 3 Plow Bolt Nut	.02

PLATE P

Extension Axle

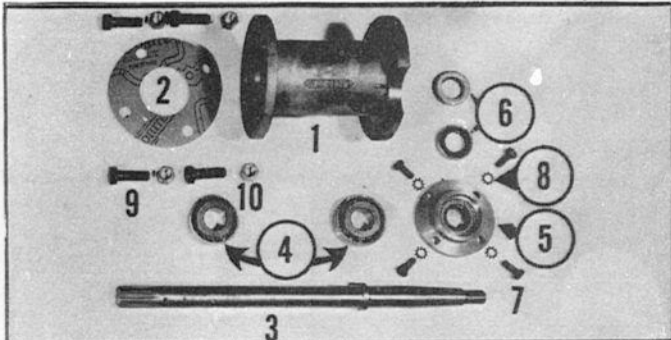

PHOTO NO.	PART NO.	DESCRIPTION	PRICE
1	L 203-B	Extension Housing	4.41
2	L 203-C	Extension Housing Gasket	.03
3	L 611-A	Extension Axle	3.18
4	L 610	Bearing Complete (Cup & Cone)	2.72
5	L 204-A	Bearing Cap	.87
6	L 221	Bearing Cap Oil Seal	.91
7	126-S	Bearing Cap Bolt	.04
8	304-W	Bearing Cap Lock Washer	.01
9	173-S	Extension Housing Bolt	.09
10	208-N	Extension Housing Nut	.03
NS	308-W	Extension Housing Bolt. Lk. Wshr.	.01

PLATE Q

Turn plow & Rear Hitch

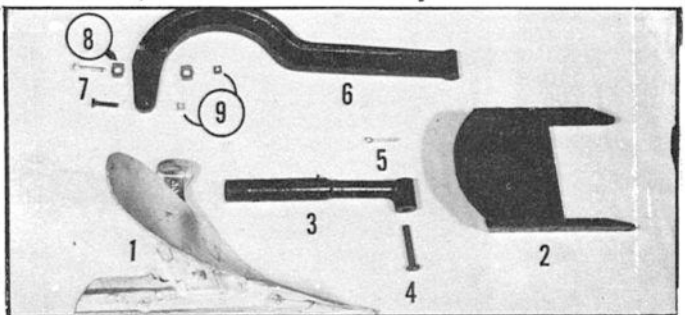

PHOTO NO.	PART NO.	DESCRIPTION	PRICE
1		Turn Plow Only	15.00
2	A 418	Rear Hitch	5.50
3	A 419	Rear Hitch Swivel	2.75
4	A 418-E	Rear Hitch Swivel Pin	.15
5	603-C	Rear Hitch Swivel Pin Cotter Key	.01
6	A 102	Plow Beam	4.50
7*		3/8" x 2 1/2" Plow Bolt	
8*		Plow Beam Corrugated Adj. Wshr.	
9*		3/8" Standard Plow Bolt Nut	
10*		3/8" x 2" Plow Bolt	
		Turn Plow Hitch & Beam Comp.	9.00
NS	A 103	Rear Toolholder Yoke	3.03

*Order these by name. Prices on request

PLATE R

Gear Reduction Wheels

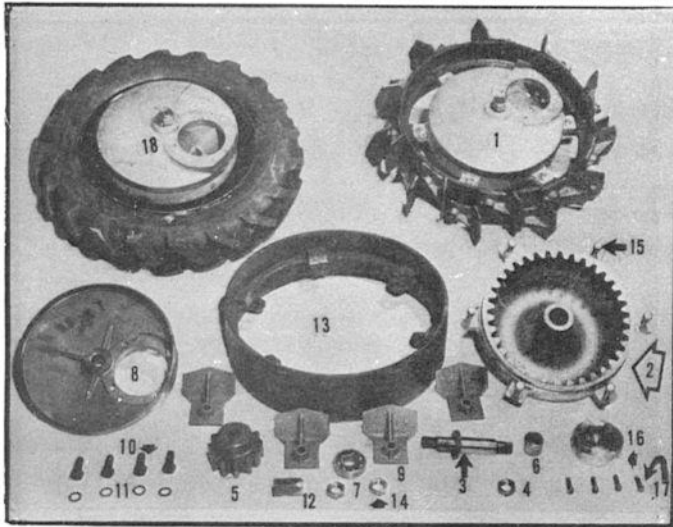

PHOTO PART NO.	DESCRIPTION	PRICE
1	Cleated Geared Wheel Complete	35.00
2	L 902 Spider Gear	15.66
3	H 354 Auxillary Axle	4.05
4	222-N Axle Securing Nut	.12
5	L 904 Axle Pinion	3.84
6	L 908 Needle Bearing	.69
7	H 358 Bearing	2.04
8	L 901-A Mounting Plate	8.88
9	2206 Cleat, Cast	.33
10	112-S Cleat Bolts (For 2206)	.05
11	305-W Cleat Bolt Lock Washer	.01
12	L 914 Wheel Knocker	.30
13	L 903 Rims	17.79
14	219-N Bearing Nut	.18
15	111-S Rim Bolt	.05
NS	305-W Rim Bolt Lock Washer	.01
16	H 129 Geared Wheel Hub Cap	1.47
17	178-S Hub Cap Bolt	.08
NS	152-S Mounting Bolt	.09
NS	308-W Mounting Bolt Lock Washer	.01
NS	L 907 Cleat, Angle Iron	.21
NS	111-S Cleat Bolt (For L 907)	.05
18	Rubber Tired Geared Wheel Comp.	40.00
NS	L 915 Wheel Rim	4.26
NS	L 916 Wheel Rim Bolt	.08
NS	L 917 Tire With Tube	12.6C
	Tire Only	10.50
	Tube Only	2.10
NS	H 128-A Geared Wheel Hub	15.78
NS	H 129-A Geared Wheel Hub Cap	1.47
NS	189-S Hub Cap Screw	.08
NS	152-S Mounting Bolt	.09
NS	308-W Mounting Bolt Lock Washer	.01

Note: Photo numbers as follows refer to parts which are the same for both cleated geared wheels and rubber tired wheels: 3, 4, 5, 6, 7, 8, 12, 14.

MODEL L ATTACHMENT ASSEMBLIES

QUANTITY	DESCRIPTION	PRICE
1	Sickle Mower Universal Assy. Complete, Less Safety Clutch	22.23
1	Safety Clutch	8.15
1	Sulky Hitch	6.27
1	Snow Plow Hitch	17.56
1	Cart Hitch	6.15
1	Wing Unit Power Take-Off Assy.	12.30
1	Wing Unit Universals Complete	32.74
1 Pr.	3" Sickle Mower Guard Ledger Plates (Ea. .09) Box 25)	1.70
	3" Sickle Mower Guard Ledger Plate Rivets (Ea. .01) Per Lb.	.29

PLATE S

Snow Plow

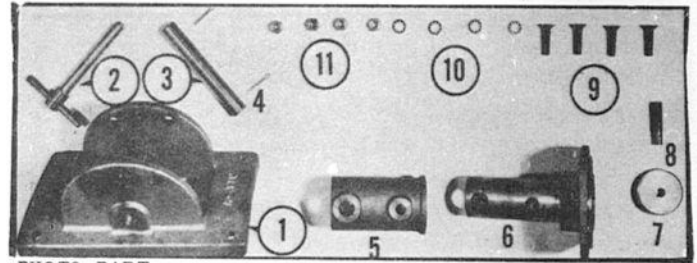

PHOTO PART NO.	DESCRIPTION	PRICE
1	A 119 Bracket	7.26
2	A 343 Adjusting Bolt and Handle	.75
3	A 332 Knuckle Pin	.75
4	606-C Cotter Pin	.01
5	A 122 Swivel Casting	3.64
6	M 101 Mounting Stud	4.03
7&8	A 344 Thrust Plug and Pin	.90
9	176-S Bracket Screw and Blade Bolt	.12
10	305-W Blade Bolt Lock Washer	.01
11	205-N Blade Bolt Nut	.03

PLATE T

Snow Plow Blade Assembly

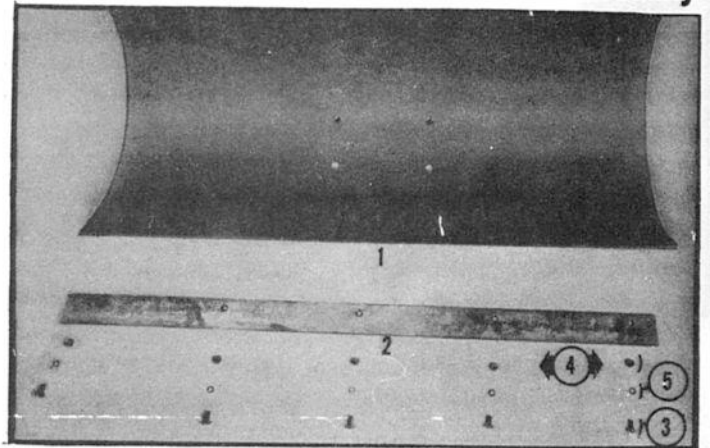

PHOTO PART NO.	DESCRIPTION	PRICE
1	A 313 Snow Plow Blade	24.10
2	A 334 Wearing Strip	4.73
3	141-S Wearing Strip Bolt	.05
4	214-N Wearing Strip Nut	.02
5	304-W Wearing Strip Bolt Lock Washer	.01

MODEL L ASSEMBLIES

QUANTITY	DESCRIPTION	PRICE
1	Motor Complete	125.00
1	Oil Pump Assembly Complete	8.65
1	Air Cleaner with Fittings for Change Over*	8.26
1	Carburetor with Fittings for Change Over*	12.80
1	Cylinder Assembly Complete With Piston And Rings	29.00
1	Fan And Bearing Assy. Comp.	8.18
1	Flywheel Assembly Complete	25.21
1 Set	Motor Gasket	1.11
1	Magneto Coil	7.50
1 Set	Magneto Points	1.50
1	Magneto Condensor	1.75
1	Front Pin Plate Assembly	22.59
1	Rear Pin Plate Assembly	17.06
1	Shipper Shaft Assembly Complete	3.04

* From models manufactured prior to 1938.

PLATE U

Power Brush Drive Assembly

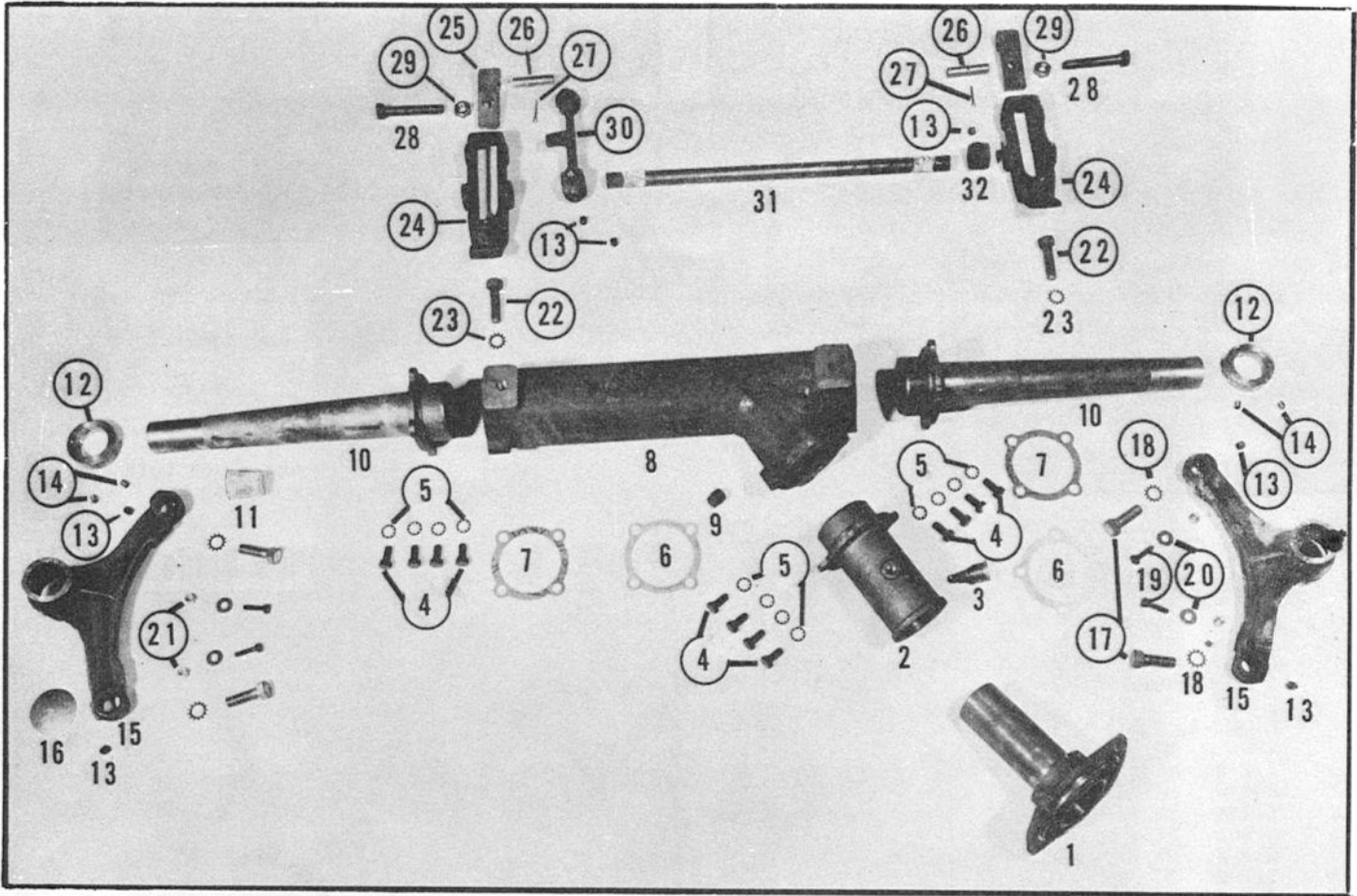

PHOTO NO.	PART NO.	DESCRIPTION	PRICE
1	M 101	Drive Shaft Housing	4.03
2	M 102	Swivel Casting	3.03
3	M 321	Grease Cup	.14
4	121-S	Gear Housing Bolt	.04
5	305-W	Gear Housing Lock Washer	.01
6	M 139	Gear Housing Shims	
		.005 Housing Adj. Shim	.07
		.020 Housing Adj. Shim	.15
7	M 326	Gear Housing Gasket	.05
8	A 115	Gear Housing	13.31
9	705-P	Gear Housing Plug	.06
10	M 104	Cross Tube	3.39
11	M 332	Cross Tube Plug	.03
12	S 321	Adj. Cross Tube Bracket Spacer	.60
13	801-A	Cross Tube Brkt. Allen Set Screw	.14
	801-A	Swivel Bracket Allen Set Screw	.14
	802-A	Thrust Collar Set Screw	.10
14	S 103	Cross Tube Bracket	5.17
15	S 320	Cross Tube Bracket Plug	.03
16	173-S	Tie Rod Cap Screw	.09
17	308-W	Tie Rod Cap Screw Lock Washer	.01
18	177-S	Hex Head Screw	.03
19	401-W	1/4" Flat Washer	.01
20	201-N	Brush Clip Bolt Nut	.02
21	171-S	Lift Bracket Bolt	.08
22	308-W	Lift Bracket Bolt Lock Washer	.01
23	S 106	Lift Bracket	3.11
24	S 107	Lift Block	.67
25	S 314	Pivot Pin	.39
26	606-C	Pivot Pin Cotter Key	.01
27	172-S	Brush Adjusting Bolt	.14
28	211-N	Adjusting Bolt Nut	.05
29	S 108	Lift Lever	1.17
30	S 304	Lift Rod	1.54
31	M 133	Lift Rod Thrust Collar	.24

PLATE V

Power Brush Drive Gears

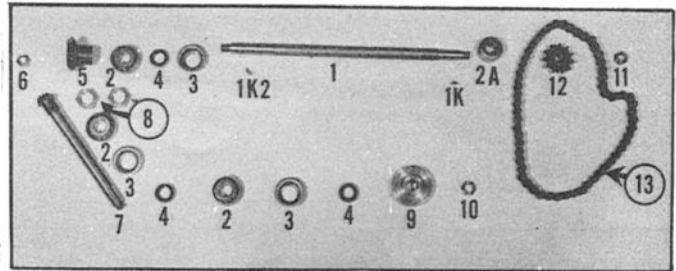

PHOTO NO.	PART NO.	DESCRIPTION	PRICE
1	S 302	Cross Shaft	2.85
1-K	503-K	Cross Shaft Woodruff Key	.02
1-K2	504-K	Bevel Gear Woodruff Key	.02
2		Bearing Assy. (Cone and Cup)	2.62
2-A	M 379	Cross Shaft Outer Bearing	2.95
3	3151	Oil Seal Retainer	.04
4	L 126	Oil Seal	.56
5	A 331	Bevel Gear	3.87
6	219-N	Castor Nut	.18
7	A 330-S	Bevel Pinion (Splined)	8.39
8	3181	Bevel Pinion Adjusting Nut	.15
9	SC 33-S	Drive Plate, Spline	1.16
10	1304	Drive Shaft Nut	.12
11	218-N	Sprocket Nut	.08
12	M 303	11 Tooth Sprocket	2.11
13	S 309	Drive Chain	5.12

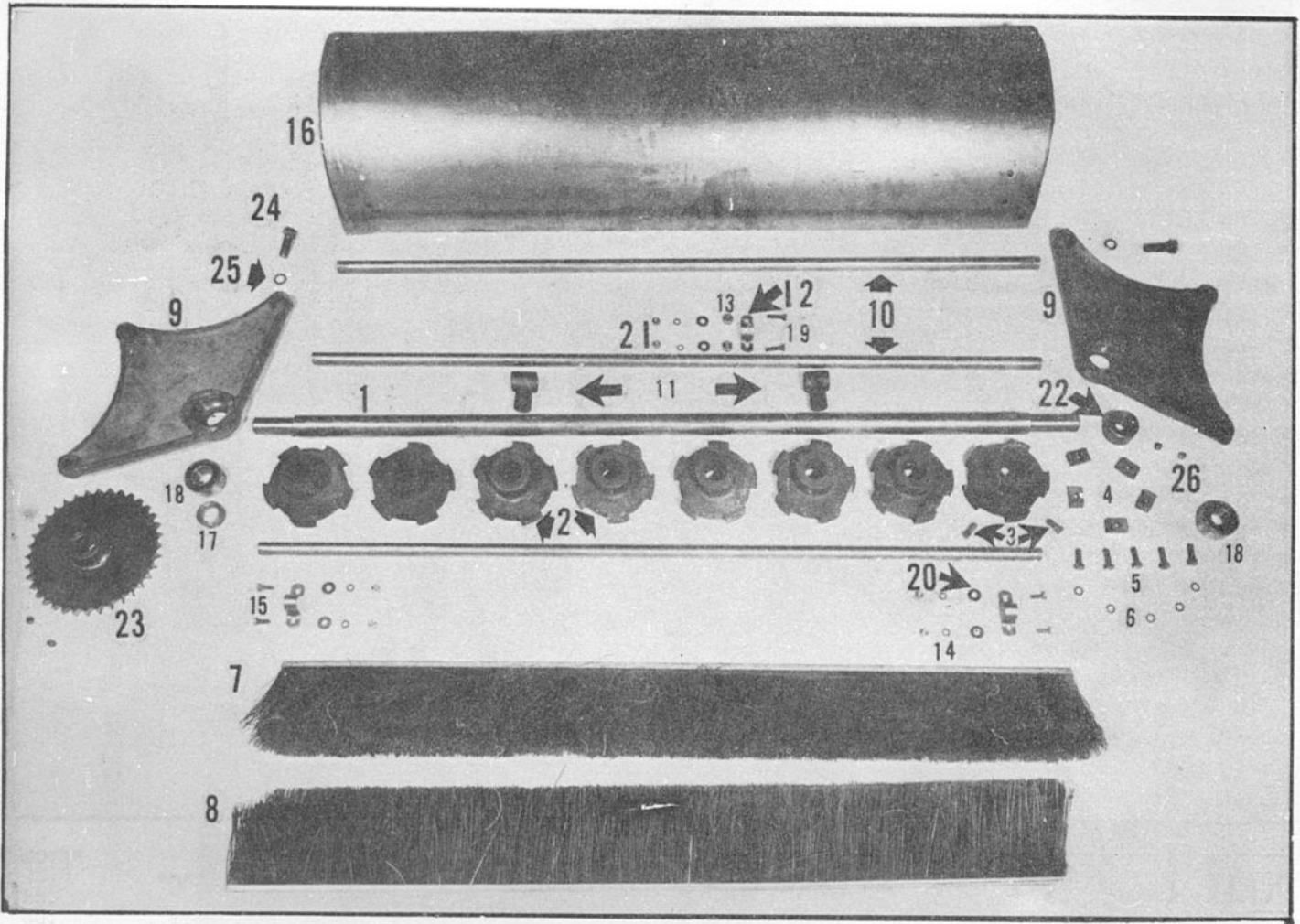

PHOTO NO.	PART NO.	DESCRIPTION	PRICE
1	S 303	Brush Shaft	3.92
2	S 101	Brush Spider	2.18
3	801-A	3/8" Spider Set Screw	.14
4	S 102	Spider Wedge	.12
5	154-S	Spider Wedge Screw	.04
6	304-W	Spider Wedge Screw Lk. Wshr.	.01
7	S 319	Bristle Strip (Coarse)	5.45
8	S 319	Bristle Strip (Fine)	4.60
9	A 116	End Casting	5.21
10	S 301	Tie Rod	1.56
11	M 112	Turn Buckle Tee	.61
12	S 316	Brush Clip	.22
13	214-N	Brush Clip Spacer Nut	.02
14	303-W	Brush Clip Bolt Lock Washer	.01
15	164-S	Brush Clip Bolt	.02
16	S 307	Brush Guard	1.17
17	S 305	Spacing Collar	.68
18	A 338	Brush Shaft Bearing	2.62
19	177-S	Hex Head Screw	.03
20	401-W	1/4" Flat Washer	.01
21	201-N	Brush Clip Bolt Nut	.02
22	S 306	Brush Shaft Thrust Collar	.71
23	S 308	36 Tooth Sprocket	4.11
24	173-S	Tie Rod Securing Screw	.09
25	308-W	Tie Rod Sec. Screw Lk. Wshr.	.01
26	801-S	End Casting Allen Set Screw	.14

SPECIAL INSTRUCTIONS

There are assemblies that are not included in this Parts and Price List Book. These include the Governor, Carburetor, Magneto, and Seeder. Special in-

PLATE X Power Brush Caster Assembly

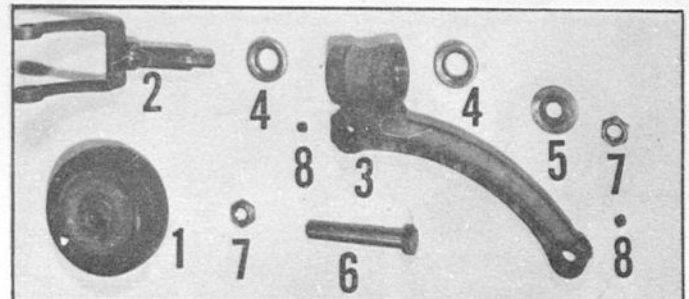

PHOTO NO.	PART NO.	DESCRIPTION	PRICE
1	S 109	Caster Wheel	3.20
2	S 105	Swivel Fork	2.77
3	S 104	Swivel Bracket	3.15
4	A 340	Caster Swivel Bearing	.97
5	S 315	Dust Washer	.75
6	S 318	Caster Axle	.60
7	218-N	Sprocket Nut	.08
8	801-A	Cross Tube Bracket Allen Set Screw	.14

structions are available for these and can be obtained by requesting them directly from your dealer.

PLATE Y

Tool Holder

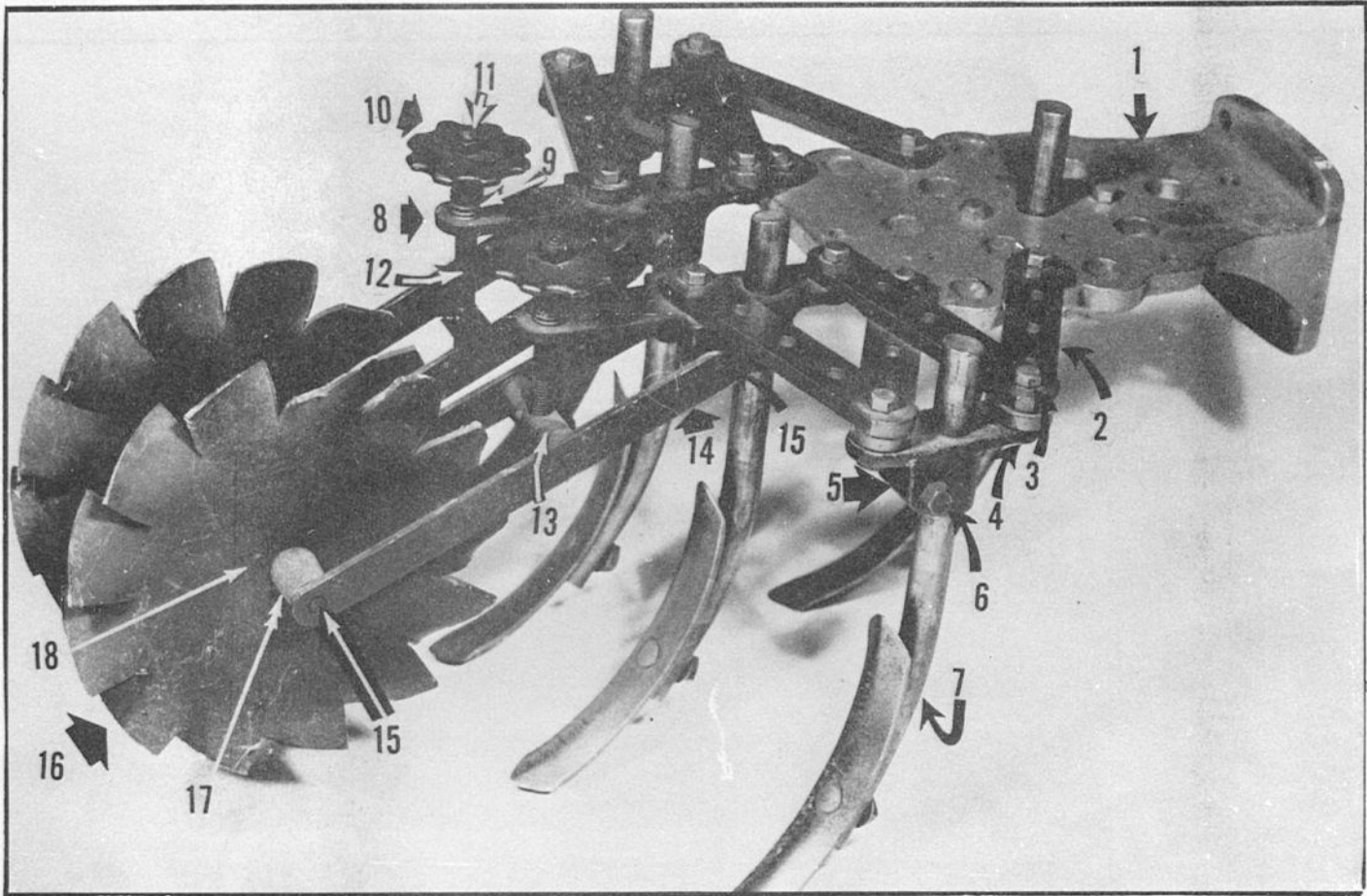

PLATE Z

Riding Sulky

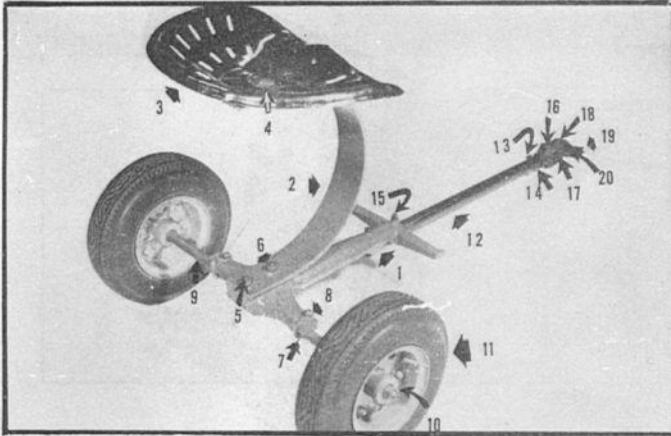

PHOTO NO.	PART NO.	DESCRIPTION	PRICE
1	5055	Front Tool Holder Frame	6.05
2	2708	Parallel Bar	.34
3	112-S	Parallel Bar Ext. Bolt	.05
4	205-N	Parallel Bar Bolt Nut	.03
5	2710	Shank Holder	.89
6	2725	Shank Clamp Bolt	.18
NS	2726	Shank Clamp Nut	.15
NS	602-C	Shank Clamp Bolt Key	.01
7	2712	Tool Shank	.49
NS	2712-A	Tool Shanks, Two Holes	.49
8	2709	Depth Wheel Bracket	1.82
9	2723	Depth Screw Friction Spring	.20
10	2721	Depth Adj. Knob	.24
11	205-N	Depth Adj. Knob Lock Nut	.03
12	2720	Depth Adj. Screw	.31
NS	403-W	Depth Adj. Screw Washer	.01
13	2724	Depth Adj. Nut	.36
14	2718	Depth Wheel Link	.36
15	2719	Depth Wheel Link Spacer	.18
16	2715	Depth Wheel	1.09
17	2716	Depth Wheel Hub	.72
18	2717	Depth Wheel Rivet	.01
NS	124-S	Screw	.05
NS	205-N	Nut	.03
14	201-N	Draw Bar Bolt Nut	.02
NS	303-W	Draw Bar Bolt Nut Lock Washer	.01
15	126-S	Frame And Draw Bar Cap Screw	.04
16	A 106	Clevis	1.41
17	A 307	Swivel Stud	.84
18	220-N	Pivot Stud Nut	.02
NS	210-N	Pivot Bolt Nut	.03
NS	308-W	Pivot Bolt Nut Lock Washer	.01
NS	A 306	Pivot Bolt	.84
19	A 304	Bracket	.45
20	1641	Alemite Fitting	.09
NS	3197-E	Pivot Stud	.12
NS	305-W	Pivot Stud Bolt Lock Washer	.01
NS	A 305	Pivot Bushing	1.05
NS	L 116	Long Crank Case Attaching Bolt	.14

PHOTO NO.	PART NO.	DESCRIPTION	PRICE
1	A 104	Sulky Frame	4.86
2	A 303	Seat Spring	3.30
3	A 443-12	Steel Seat	1.80
4	180-S	Seat Bolt	.07
NS	211-N	Seat Bolt Nut	.05
NS	308-W	Seat Bolt Nut Lock Washer	.01
5	152-S	Spring Bolt	.09
6	211-N	Spring Bolt Nut	.05
7	A 311	Axle U Bolt	.18
8	214-N	U Bolt Nut	.02
NS	304-W	U Bolt Nut Lock Washer	.01
9	A 310	Axle	2.82
10	219-N	Axle Nut	.18
11	A 320	Wheel Complete (Each)	11.20
12	A 309	Draw Bar	1.26
13	149-S	Draw Bar Bolt	.06

ROTARY MOWER OPERATING INSTRUCTIONS

A good lawn deserves the best of mowers. Your lawn, no matter how well turfed, or how green and firm, will not be lovely if your mowing is streaked and uneven.

The GRAVELY Rotary Mower Attachment turns your GRAVELY Tractor into the finest mower you can buy. Precision machining, and long testing and development in the field have had one purpose in mind--to give you a lawn mower that will do a professional job on your lawn, with the minimum of care and adjustment.

The GRAVELY Rotary Mower will not streak or scalp your lawn--instead, it will give you a clean, even mowing job every time.

To get the best results with your Mower, read these instructions carefully. The adjustments are simple, but they must be made correctly to insure a good job. The care of your Mower is very important also. Follow these instructions, and your Rotary Mower will last you for many years.

ATTACHING

The GRAVELY Rotary Mower (30 inch center unit) is attached to the Tractor by the use of four bolts in the same manner as all other power attachments.

LUBRICATION

The Swivel Casting (Plate AA Photo No. 8) is equipped with an Alemite Fitting (Plate AA Photo No. 11). It is easily located on the right hand side of the Swivel Casting on the Assembled Unit.

This fitting should be lubricated as needed. A simple rule is to lubricate it before you start your mowing. Use Mobilgrease No. 2.

The Gear Housing (Plate AA Photo No. 17) is found at the center of the Mower. Once a year, remove the Strut (Plate AA Photo No. 25) and drain all the old oil. Replace the Strut, and remove the Gear Housing Plug (Plate AA Photo No. 44) and the Oil Level Pipe Plug on the front of the Strut. (The Oil Level Pipe Plug is not shown, it was added after the photograph was made). Fill the Gear Housing through the Gear Housing Plug hole until oil runs out, or is level with the bottom of the Oil Level Pipe Plug hole. Use Mobilube C (SAE 140 Gear Oil.) Never use more oil than is needed to fill the Gear Housing to the bottom of the Oil Level Pipe Plug hole. Too much oil will cause overheating and consequent damage to the gears. Be sure to replace both the Gear Housing Plug and the Oil Level Pipe Plug before you start mowing. The position of the Reel Bearing Alemite Fitting is indicated on (Plate BB Photo No. 20). These angle fittings (shown as straight fittings on the plate) should be given a shot of Mobilgrease No. 2 as needed.

There are four alemite fittings on the spacers holding the Rollers in their proper position of the Roller Bar type of reel. Use Mobilgrease No. 2 in these fittings also, and grease as needed to insure free rolling of the Wooden Rollers.

All other bearings and bushings are life lubricated at the factory.

REEL ADJUSTMENT

The Bed Knife Bar should set up close enough to the reel so that it is touching lightly along its entire length. To test this adjustment, use a piece of paper at different points on the Bed Knife, turning the reel with your hand. If the knife cuts the paper cleanly at each point along the Bed Knife Bar, the Reel is in proper adjustment. If the Knife does not cut the paper cleanly, adjustment is made by tightening or loosening the Reel Adjusting Screw (Plate BB Photo 21). To adjust, loosen the Locking Nut (Plate BB Photo No. 22) and turn the screw either left or right. Tightening the screw (turning to the right) will move the reel away from the Bed Knife Bar, loosening the screw will allow it to press firmer against the Bed Knife Bar.

For example, suppose that you are facing the reel, and have tested the cut. You have found that the reel is light on the left side, too heavy on the right. Loosen the lock nut on the left Adjusting Screw, loosen the screw slightly. Then loosen the lock nut on the right, and tighten the right Adjusting Screw lightly. Lock the nuts again. This should give you the proper adjustment all along the reel.

Occasionally the castings will warp very slightly. This condition is common to most castings, unless they have been "seasoned" a long time. To correct this warping, merely reverse lap your reel as described in instructions on REVERSE LAPPING OF THE REEL.

INSTALLATION OF V-BELTS

To install the V-Belts, loosen the Height Adjusting Screw Lock Nut, releasing the Height Adjusting Screw. Then turn the Height Adjusting Screw until it releases the Reel Assembly from the Strut. Raise the Mower slightly and swing the reel backwards (toward the Tractor) until the belts are loose on the pulley. Remove the old belts and replace with the new belts. After the new belts are in place, return Mower to normal position, replace the Height Adjusting Screw and re-adjust the mowing height.

ADJUSTMENT OF V-BELTS

Your mower is equipped with a special V-Belt Adjusting Bolt (Plate BB Photo No. 50). The V-Belts should have one inch of play in them. That is, without forcing, but with firm pressure on one side of the V-Belt, (halfway from each pulley) it should give one inch.

To tighten turn the Belt Adjusting Bolt (Plate BB Photo No. 50) clockwise, to loosen turn the Belt Adjusting Bolt counter-clockwise. When tightening, if the Belt Adjusting Bolt is turned as far as it will go and the belts do not tighten, the belts should be replaced.

REVERSE LAPPING OF THE REEL

The 1949 Rotary Mower has a specially designed reverse

for lapping the Reel against the Bed Knife. This will eliminate, in many cases, grinding of the Reel. It is advisable to lap the reel in whenever the reel is adjusted against the Bed Knife Bar.

To lap the Reel, loosen the bolt (Plate AA Photo No. 28) on the front of the Gear Housing. This bolt is off center. To reverse the reel, slowly roll the reel back and forth with the hand, pushing the bolt to the opposite side of the housing. This engages the reverse. When it is engaged, tighten the bolt.

Then apply a 60 grit lapping compound to the reel with a paint brush with the attachment running at normal speed. Allow the reel to lap in reverse until the reel makes good contact with the Bed Knife Bar along its entire length.

To put the reel back in forward gear, use the same

procedure as described above, except that you push the bolt to the right.

ADJUSTING THE HEIGHT OF CUT

Cutting height is adjusted by means of the Height Adjusting Screw (Plate AA Photo No. 42), Height Adjusting Screw Nut (Plate AA Photo No. 41), and the Height Adjusting Screw Lock Nut (Plate AA Photo No. 43).

Loosen the Height Adjusting Screw Lock Nut, and turn the Height Adjusting Screw to the right to raise the height of cut, and to the left to lower the height of the cut. When the adjustment suits your requirements, lock the Height Adjusting Screw Lock Nut to hold the adjustment, and you are ready to mow.

GANG MOWER OPERATING INSTRUCTIONS

Large mowing areas deserve the same care and treatment that you give your smaller areas. By attaching two 25 inch Gang Mowing Units to your GRAVELY Rotary Mower, your large lawns can be mowed in a minimum of time. There is no streaking and no scalping with the Gang Units. Like the Rotary Mower, they have Swivel Action which allows them to follow the contour of the ground. They do not depend upon traction for power--they are completely power driven from the tractor.

With the Gang Mowing Units attached to your Rotary Mower, you mow a swath 72 inches in width--and the mowing is done cleanly and evenly.

ASSEMBLY OF GANG MOWING UNITS

Three of the Attaching Units come to you already assembled. These are: the Power Take Off (the Wing Bracket with the Wing Drive Pulleys); the Universal Drive Assembly (the Spacer Shaft, the Universal Disc, the Locking Ring, etc.); and the Leader (attached to the Gang Mowing Unit Tie Rod.)

POWER TAKE OFF

To install the Power Take Off the Center Unit must first be detached from the tractor. This is done so that the Wing Bracket can be fitted to the Swivel Casting on the Center Drive Assembly. Follow these steps closely to install the Power Take Off:

1. Detach the Center Unit from the Tractor. Remove the nut from the Drive Shaft (Plate AA Photo No. 1) and take the Safety Slip Clutch off. Next, remove the Drive Shaft Housing (Plate AA Photo No. 5).

2. Loosen the Wing Bracket Nut (Plate CC Photo No. 25) on the Wing Bracket (Plate CC Photo 17). Place the Wing Bracket Securing Key (Plate CC Photo No. 23) in the keyway underneath the Swivel Casting. Fit the Wing Bracket on the machined area of the Swivel Casting (Plate AA Photo No. 8) with the Pulley Assembly in a downward position, and with the Wing Bracket Securing Key in a position so it will fit into the Keyway on the inside ring of the Wing Bracket.

3. Replace the Drive Shaft Housing, the Safety Slip Clutch, and the Drive Shaft Nut

This completes the installation of the Power Take Off Assembly. The Center Unit is ready to be attached to the Tractor.

DRIVE PULLEYS AND BELTS

Notice the openings in the Drive Column Housings (Plate AA Photo No. 18) on either side of the Gear Housing (Plate AA Photo No. 17) on the Center Unit. The Inner Wing Drive Pulleys are installed here by:

1. Loosen the Height Adjusting Screw Lock Nut (Plate AA Photo No. 43) on the Center Unit. This releases the Height Adjusting Screw (Plate AA Photo No. 42). Turn the Height Adjusting Screw until it releases the Reel Assembly from the Strut (Plate AA Photo No. 25). Lift up on the Drive Column Housing so that the Reel Assembly clears the ground and is free to move. Swing the Reel Assembly backwards, or towards the tractor, until the Drive Belts can be easily removed.

2. Remove the Outer Cross Shaft Bearing Retainer Cap Screws (Plate AA Photo No. 35) from the Outer Cross Shaft Retainer (Plate AA Photo No. 33) on the Drive Column Housing (Plate AA Photo No. 18). Pull the Cross Shaft (Plate AA Photo No. 31) out just enough to insert the Inner Wing Drive Pulley (Splined) (Plate CC Photo No. 26) into the opening on the Drive Column Housing. Fit the Inner Wing Drive Pulley with the Wing Drive Belt (Plate CC Photo No. 27) around it to the Splined end of the Cross Shaft.

3. Replace the Cross Shaft. Replace the Bearing Cap and Bearing Cap Screws. Replace the Drive Belts on the Outer Drive Pulley, and attach the Height Adjusting Screw to the Strut. (For Height Adjustment refer to Rotary Mower Instructions.)

4. Fit the Wing Drive V-Belt to the Wing Drive Pulley (Plate CC Photo No. 22) on the Power Take Off Assembly.

ATTACHING THE LEADER TO THE CENTER UNIT

1. Place the Leader Swivel Pivot Stud (Plate CC Photo No. 43) through the Leader Pivot (the side with the Alemite Fitting) (Plate CC Photo No. 41). Also place the Leader Pivot Spacer (Plate CC Photo No. 42) onto the Leader Swivel Pivot Stud.
2. Remove the top Tie Rod Bolt (Plate BB Photo No. 32) from the Center Unit. Attach in its place the Leader Swivel Pivot Stud (with the Leader Pivot and the Leader Pivot Spacer).
3. Attach the Leader Swivel (Plate CC Photo No. 29) to the Leader Pivot (Plate CC Photo No. 41). Secure together with the Leader Pin (Plate CC Photo No. 33).

ATTACHING UNIVERSAL DRIVE ASSEMBLY TO GANG MOWING UNIT

To fit the Gang Mowing Unit to the Universal Drive Assembly:

1. Loosen the Wing Spider Set Screws (Plate CC Photo No. 12) on the Wing Spider (Plate CC Photo No. 11).
2. Slip the Wing Spider of the Universal Drive Assembly on the shaft of the Gang Unit Reel (Plate DD Photo No. 21) and tighten the Wing Spider Set Screws.

ATTACHING UNIVERSAL DRIVE ASSEMBLY TO POWER TAKE OFF ASSEMBLY

The next step is to attach the Universal Drive Assembly to the Power Take Off. This is done by:

1. Examine each end of the Universal Drive Assembly. Notice the Locking Ring (Plate CC Photo No. 5) on the Spacer Shaft (Plate CC Photo No. 9). The Locking Ring is held in place by the Locking Spring (Plate CC Photo No. 4). Press the Locking Ring on the Universal Assembly back from the end of the Spacer Shaft as far as it will go.
2. Place the Locking Ring over the end of the Universal Drive Shaft so that the Locking Balls (Plate CC Photo No. 3) are in line with the holes on the Universal Drive Shaft (Plate CC Photo No. 19). Release the Locking Ring and the Universal Drive Assembly locks to the Universal Drive Shaft.

ADJUSTMENTS

WING DRIVE V-BELTS

These belts running from the Inner Wing Drive Pulleys to the Wing Drive Pulleys are adjusted by moving the Wing Bracket on the Swivel Casting of the Center Unit. To tighten the Belts move the Wing Bracket toward the Attachment Flange on the Drive Shaft Housing, to loosen move the Wing Bracket away from the Attachment Flange.

Proper adjustment of the V-Belts is reached by:

1. Applying firm pressure to the top of the

Belt halfway between the two pulleys.

2. If properly adjusted the Belts will give one inch without forcing. If the Belts are too loose or too tight, adjust the Wing Bracket until the Belts, when pressure is applied, will give an inch.

3. When proper adjustment is reached, tighten the Wing Bracket Nut (Plate CC Photo No. 25) on the Wing Bracket.

It is very important that these belts be properly adjusted at all times.

LEADER

To get the best results from your Gang Mowing Units it is essential that the Leader be adjusted properly. When the Leader has been attached to the Center Unit and the Universal Assembly has been connected to the Power Take Off, the Gang Mowing Unit should be parallel with the Center Unit. If it is not, make the following adjustment:

Loosen the Leader Adjusting Bracket Thrust Collar Set Screws (Plate CC Photo No. 40) on the Leader Adjusting Bracket Thrust Collar (Plate CC Photo No. 39). This allows the Leader to move freely on the Gang Mowing Unit Tie Rod (Plate DD Photo No. 25). The Leader Adjusting Bracket (Plate CC Photo No. 36) is moved by tapping lightly with a hammer.

Move the Gang Mowing Unit so that it is parallel with the Center Unit. Place the Thrust Collars against the arms of the Leader, secure the Leader in position by tightening the Thrust Collar Set Screws.

Remember--a Gang Mowing Unit that is not running parallel with the Center Unit will not operate properly.

MOWING HEIGHT

The Mowing Height for the Gang Mowing Units should be adjusted to the same height of the Center Unit. To make this adjustment:

1. Locate the Wing Height Adjusting Screw (Plate CC Photo No. 37) and the Wing Height Adjusting Lock Nut (Plate CC Photo No. 38) on the Leader Adjusting Bracket (Plate CC Photo No. 36).
2. Loosen the Wing Height Adjusting Lock Nut.
3. To increase the Mowing Height turn the Wing Height Adjusting Screw clock-wise. To decrease the Mowing Height turn the Wing Height Adjusting Screw counter-clockwise.
4. When the Gang Unit is adjusted to the desired Mowing Height, lock the Wing Height Adjusting Screw by tightening the Wing Height Adjusting Lock Nut.

LUBRICATION

REEL

(Same as for Center Unit)

ROLLER

(Same as for Center Unit)

LEADER

There are two points of lubrication on the Leader Assembly. One is the Alemite Fitting on the Leader Swivel (Plate CC Photo No. 31), the other is the Alemite Fitting on the Leader Pivot (Plate CC Photo No. NS). These should be lubricated as needed with Mobilgrease No. 2

WING DRIVE SHAFT

The Wing Drive Shaft Bearings are permanently sealed in oil and therefore require no lubrication.

REVERSE LAPPING OF THE GANG REEL

Sharpen the Gang Mowing Unit Reels at the same time the Center Unit Reel is sharpened. By reversing the Center Unit Reel (as described in the Rotary Mower

Instructions) the Gang Mowing Unit Reels are also reversed. They are sharpened in the same manner as the Center Unit Reel.

TRANSPORTING THE GANG MOWING UNITS

Taking the Mowers from one job to another does not require completely detaching the Gang Units from the Center Unit.

Remove the Locking Ring on the Universal Drive Assembly from the Power Take Off. This is done by pressing the Locking Ring away from the Power Take Off. This frees the Locking Balls and allows the Universal Drive Assembly to slip away from the Power Take Off. Follow this procedure for both Gang Mowing Units.

With the Universal Assemblies detached, lift up on the Unit, turn it so that the loose Universal Assembly will be at the front of the Center Unit. Place it on the Center Unit so that the Roller Bar on the Gang Mowing Unit will rest on the Drive Column Housing. Follow this procedure for both Gang Mowing Units and the mowers are ready to be transported.

PLATE AA

Rotary Mower Drive Assembly

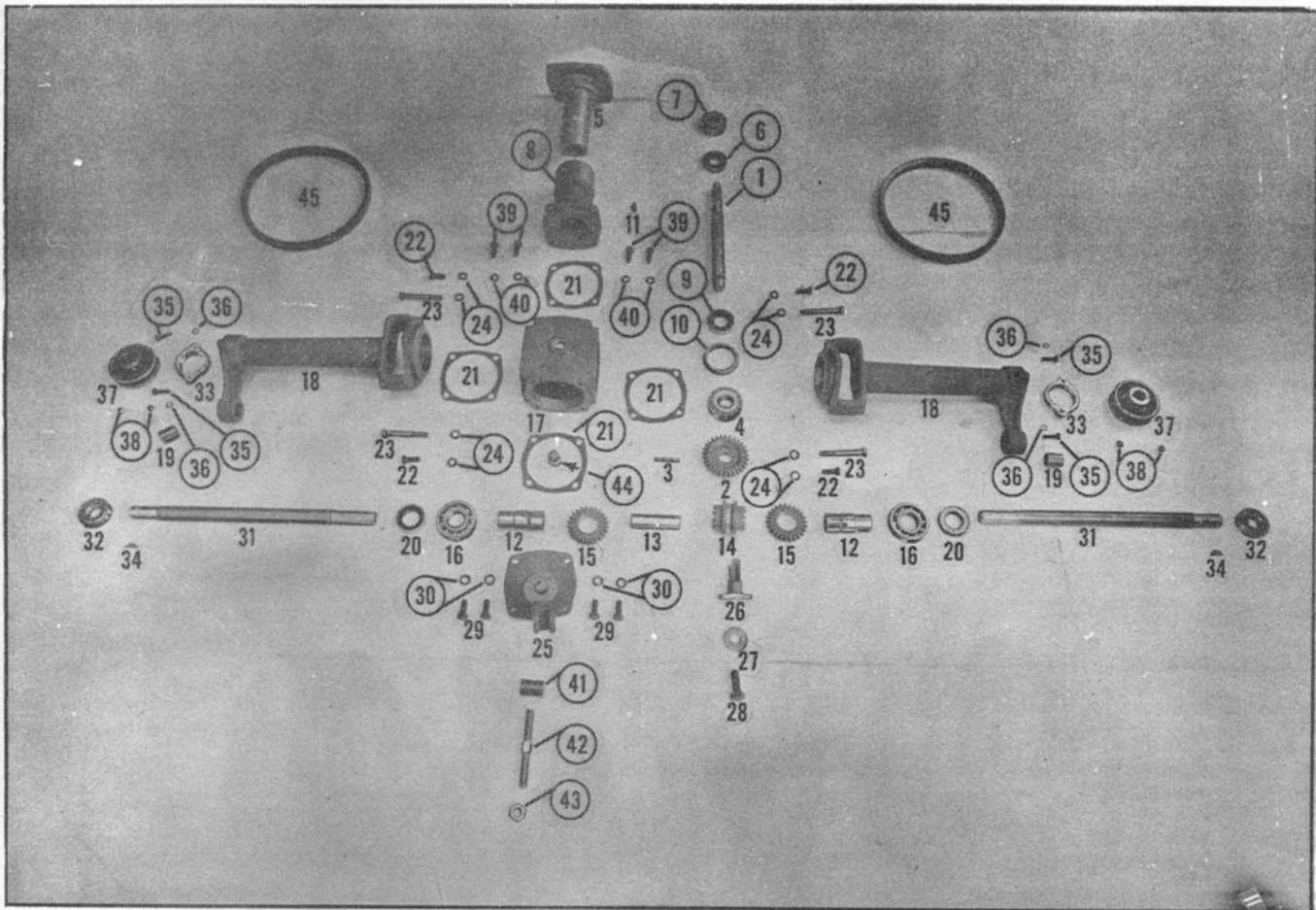

PHOTO NO.	PART NO.	DESCRIPTION	PRICE	PHOTO NO.	PART NO.	DESCRIPTION	PRICE
1	M 445	Drive Shaft	2.08	25	M 153	Strut	2.41
2	M 440	Bevel Gear	5.52	NS	701-P	Strut Oil Level Plug	.05
3	M 489	Bevel Gear Rivet	.02	26	M 164	Shifting Fork	2.11
4	L 610	Drive Shaft Bearing Cone	1.64	27	410-W	Shifting Fork Bolt Flat Washer	.01
	M 478	Drive Shaft Bearing Cup	1.08	28	152-S	Shifting Fork Bolt	.09
5	M 150	Drive Shaft Housing	4.03	29	110-S	Strut Bolt	.05
6	M 459	Outer Drive Shaft Bearing Seal	.90	30	305-W	Strut Bolt Lock Washer	.01
7	3147	Drive Shaft Bearing Complete	2.62	31	M 446	Cross Shaft	1.50
8	M 151	Swivel Casting	3.99	32	M 323	Outer Cross Shaft Bearing	2.75
9	M 460	Inner Drive Shaft Bearing Seal	1.00	33	M 158	Outer Cross Shaft Brg. Retainer	.59
10	Discontinued			34	504-K	Cross Shaft Key (Woodruff)	.02
11	M 480	Swivel Casting Alemite Fitting	.09	35	183-S	Outer Cross Shaft Brg. Retainer	
12	M 439	Driving Socket	1.50			Cap Screw	.03
13	M 485	Cross Tube	.60	36	303-W	Outer Cross Shaft Brg. Retainer	
14	M 438	Driving Dog	3.60			Cap Screw Lock Washer	.01
15	M 441	Bevel Pinion	4.95	37	M 137	Outer Drive Pulley (3")	.99
16	M 458	Inner Cross Shaft Bearing	3.25	38	801-A	Outer Drive Pulley Set Screw	.14
17	M 152	Gear Housing	6.50	39	110-S	Gear Housing Bolt, Short	.05
18	M 156	Drive Column Housing	5.15	40	305-W	Gear Housing Bolt Lock Washer	.01
19	M 502	Pivot Stud Bearing Bushing	.18	41	M 356	Height Adjusting Screw Nut	.28
20	M 465	Cross Shaft Bearing Seal	.90	42	M 352	Height Adjusting Screw	.45
21	M 488	Gear Housing Gasket	.04	43	211-N	Height Adjusting Screw Lk. Nut	.05
22	110-S	Gear Housing Bolt, Short	.05	44	702-P	Gear Housing Plug	.06
23	192-S	Gear Housing Bolt, Long	.09	NS	701-P	Oil Level Pipe Plug	.05
24	305-W	Gear Housing Bolt, Lock Washer	.01	45	M 475	Drive Belt	.80

PLATE BB

Rotary Mower Center Unit Reel Assembly

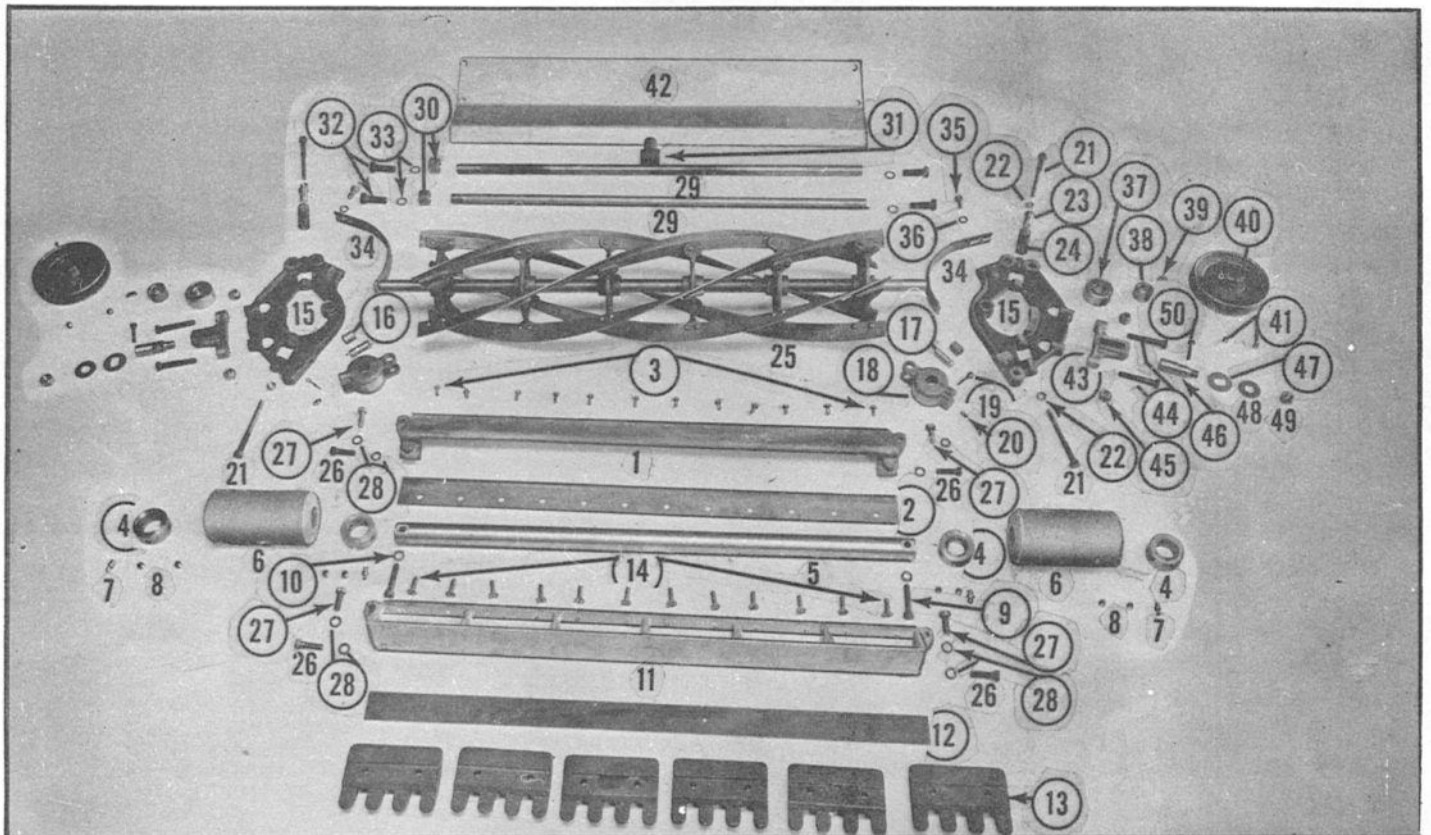

PHOTO NO.	PART NO.	DESCRIPTION	PRICE
1	M 134	Bed Knife Bar, Roller Type	10.50
2	M 429-L	Bed Knife Steel 30", Roller Type	1.90
3	175-S	Bed Knife Screw	.01
4	M 513	Roller Thrust Collar	.70
5	M 506	Long Roller Bar	1.52
6	M 448	Roller, Wood	1.20
7	M 480	Roller Alemite Fitting	.09
8	801-A	Roller Thrust Collar Set Screw	.14
9	124-S	Roller Bar Bolt	.05
10	305-W	Roller Bar Bolt Lock Washer	.01
11	M 121	Bed Knife Bar, Skid Type	10.50
12	M 353	Bed Knife Steel 30", Skid Type	3.28
13	M 123	Bed Knife Bar Skid	.73
14	141-S	Bed Knife Bar Skid Bolt	.05
15	M 172	End Casting	4.90
16	M 359	Pivot Bushing	.15
17	M 360	Pivot Pin	.20
18	M 120	Reel Bearing Housing	2.12
19	607-C	Pivot Cotter Pin	.01
20	6013	Reel Bearing Hsg. Alemite Fitting	.12
21	M 351	Reel Adjusting Screw	.18
22	220-N	Reel Adjusting Screw Lock Nut	.02
23	M 511	Reel Adjusting Spring Thimble	.30
24	2723	Reel Adjusting Spring	.20

PHOTO NO.	PART NO.	DESCRIPTION	PRICE
25	M 339	Reel	32.84
26	112-S	Bed Knife Bar Bolt, Long	.05
27	111-S	Bed Knife Bar Bolt, Short	.05
28	305-W	Bed Knife Bar Bolt Lock Washer	.01
29	M 508	Long Tie Rod	1.20
30	M 510	Tie Rod Adjusting Nut	.12
31	M 112-A	Turn Buckle Tee	.61
32	173-S	Tie Rod Bolt	.09
33	308-W	Tie Rod Bolt Lock Washer	.01
34	M 512	Skid	.45
35	121-S	Skid Bolt	.04
36	305-W	Skid Bolt Lock Washer	.01
37	M 379	Reel Bearing	2.95
38	M 362	Pulley Spacer	.15
39	504-K	Pulley Locking Key (Woodruff)	.02
40	M 428	Reel Drive Pulley (5")	1.45
41	801-A	Pulley Set Screw	.14
42	M 470	Reel Guard	.90
43	M 159	Vee Belt Adjusting Bracket	.69
44	151-S	Vee Belt Adjusting Bracket Bolt	.06
45	228-N	Vee Belt Adj. Bracket Bolt Elastic Stop Nut	.14
46	M 500	Pivot Stud	.45
47	M 501	Pivot Stud Thrust Collar	.07
48	410-W	Thrust Collar Flat Washer	.01
49	208-N	Pivot Stud Securing Nut	.03
50	185-S	Belt Adjusting Bolt	.05

PLATE CC

Gang Mower Drive Assembly

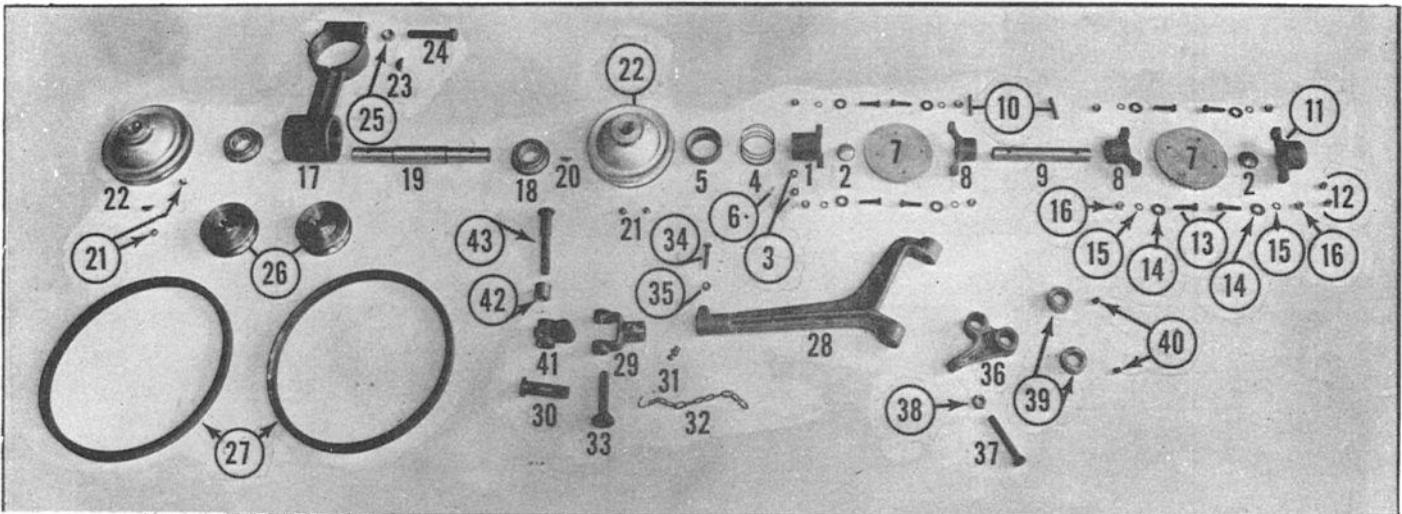

PHOTO NO.	PART NO.	DESCRIPTION	PRICE
1	M 343-A	Take Off Spider	2.40
2	M 343-F	Short Core Plug	.20
3	M 343-K	Locking Ball	.03
4	M 343-I	Locking Spring	.15
5	M 343-G	Locking Ring	1.20
6	M 343-H	Locking Ring Stop	.03
7	M 343-J	Universal Disc	.66
8	M 343-C	Center Spider	1.95
9	M 343-D	Spacer Shaft	.95
10	M 343-L	Spacer Shaft Rivet	.03
11	M 343-B	Wing Spider	2.40
12	801-A	Wing Spider Set Screw	.14
13	193-S	Universal Disc Bolt	.03
14	401-W	Universal Disc Flat Washer	.01

PHOTO NO.	PART NO.	DESCRIPTION	PRICE
15	303-W	Universal Disc Lock Washer	.01
16	201-N	Universal Disc Nut	.02
17	M 154	Wing Bracket	4.50
18	M 457	Wing Drive Shaft Bearing	2.95
19	M 435	Universal Drive Shaft	2.90
20	504-K	Wing Drive Pulley Key (Woodruff)	.02
21	801-A	Wing Drive Pulley Set Screw	.14
22	M 155	Wing Drive Pulley (5")	2.75
23	508-K	Wing Bracket Securing Key (Woodruff)	.02
24	184-S	Wing Bracket Bolt	.13
25	220-N	Wing Bracket Nut	.02
26	M 430	Inner Wing Drive Pulley (3") (Splined)	1.10
NS	1641	Alemite Fitting	.09

PHOTO NO.	PART NO.	DESCRIPTION	PRICE	PHOTO NO.	PART NO.	DESCRIPTION	PRICE
27	M 475	Wing Drive Vee Belt	.80	37	124-S	Wing Height Adjusting Screw	.05
28	M 128	Leader	2.40	38	205-N	Wing Height Adjusting Lock Nut	.03
29	M 127	Leader Swivel	1.35	39	M 133	Leader Adjusting Bracket Thrust Collar	.20
30	M 348	Leader Swivel Stud	.60	40	801-A	Leader Adjusting Bracket Thrust Collar Set Screw	.14
31	1641	Leader Swivel Alemite Fitting	.09	41	M 126	Leader Pivot	.73
32	M 505	Leader Pin Chain	.06	NS	1641	Leader Pivot Alemite Fitting	.06
33	M 349	Leader Pin	.60	42	M 487	Leader Pivot Spacer	.19
34	M 383	Leader Clamp Bolt	.10	43	M 486	Leader Swivel Pivot Stud	.90
35	202-N	Leader Clamp Bolt Nut	.02				
36	M 129	Leader Adjusting Bracket	1.35				

PLATE DD

Gang Mower Reel Assembly

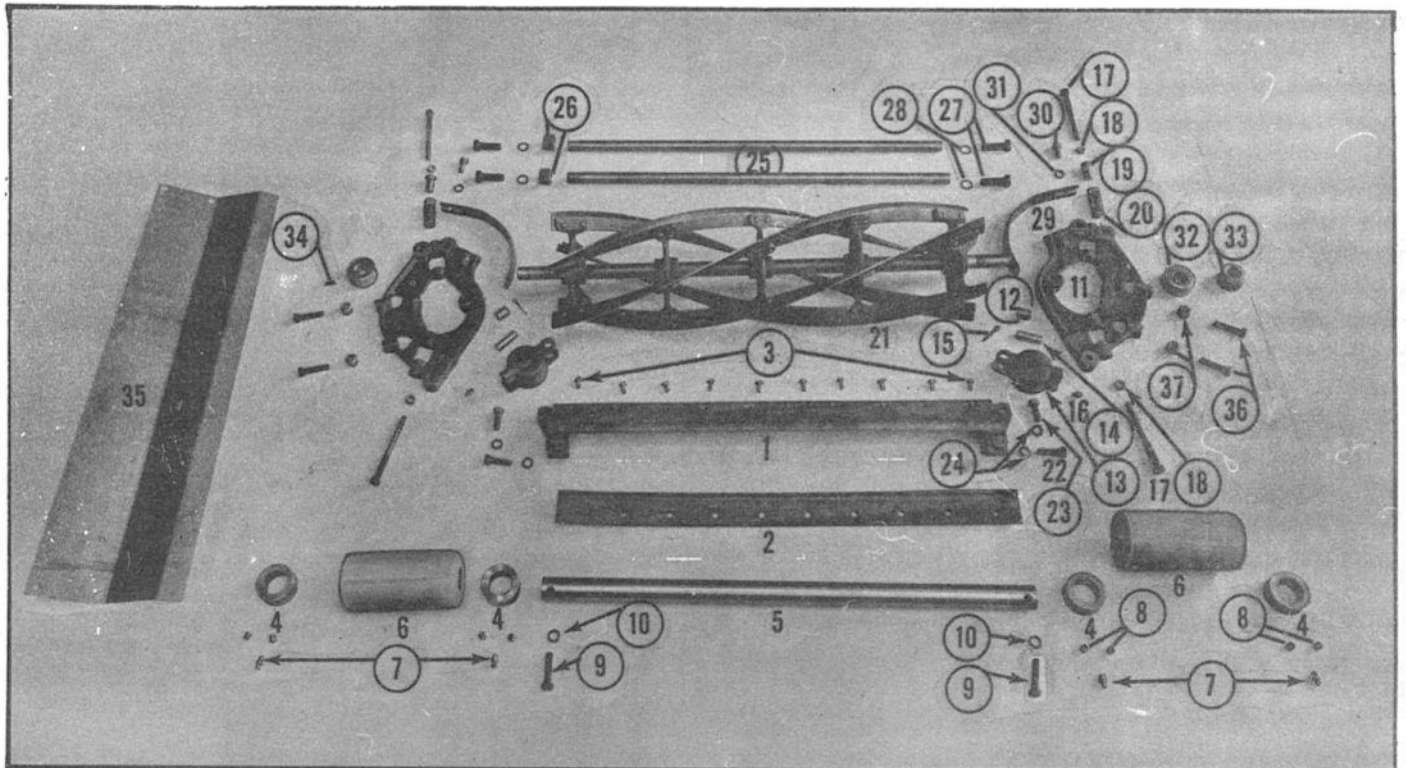

PHOTO NO.	PART NO.	DESCRIPTION	PRICE	PHOTO NO.	PART NO.	DESCRIPTION	PRICE
1	M 135	Bed Knife Bar (25")	9.30	20	M 343-I	Reel Adjusting Spring	.15
2	M 429-S	Bed Knife Steel (25")	1.60	21	M 340	Reel	29.55
3	175-S	Bed Knife Screw	.01	22	112-S	Bed Knife Bar Bolt, Long	.05
4	M 513	Roller Thrust Collar	.70	23	111-S	Bed Knife Bar Bolt, Short	.05
5	M 507	Roller Bar (25")	1.35	24	305-W	Bed Knife Bar Bolt Lock Washer	.01
6	M 448	Roller, Wood	1.20	25	M 509	Short Tie Rod	1.00
7	M 480	Roller Alemite Fitting	.09	26	M 510	Tie Rod Adjusting Nut	.12
8	801-A	Roller Thrust Collar Set Screw	.14	27	173-S	Tie Rod Bolt	.09
9	124-S	Roller Bar Bolt	.05	28	308-W	Tie Rod Bolt Lock Washer	.01
10	305-W	Roller Bar Bolt Lock Washer	.01	29	M 512	Skid	.45
11	M 172	End Casting	4.90	30	121-S	Skid Bolt	.04
12	M 359	Pivot Bushing	.15	31	305-W	Skid Bolt Lock Washer	.01
13	M 120	Reel Bearing Housing	2.12	32	M 379	Reel Bearing	2.95
14	M 360	Pivot Pin	.20	33	M 361	Reel Bearing Thrust Collar	.60
15	607-C	Pivot Cotter Pin	.01	NS	801-A	Reel Bearing Thrust Collar Set Screw	.14
16	6013	Reel Bearing Housing Alemite Fitting	.12	34	504-K	Wing Spider Key	.02
17	M 351	Reel Adjusting Screw	.18	35	M 471	Reel Guard	.90
18	220-N	Reel Adjusting Lock Nut	.02	36	137-S	Reel Guard Bolt	.04
19	M 511	Reel Adjusting Thimble	.30	37	228-N	Reel Guard Nut	.14

Be sure the Blade is dry, then coat it thickly with the Mobilgrease No. 2.

If you use your Saw a great deal, eventually you will have to have it sharpened and set. We recommend that you take your Saw Blade to your GRAVELY Dealer. If he is not set up to sharpen and set your Saw, he can recommend a Saw Sharpening establishment where you can be assured of good work.

Simple rules to save your Saw Blade and increase its life are: 1. Keep it out of dirt and rocks. 2. Give your Saw a rest once in a while. Sawing gets your Saw Blade hot, and you should let it cool down occasionally. 3. Keep it free from rust, stored out of the weather.

CHANGING SAW POSITION

When the Saw Blade is locked in position, only the flat side of the Index Key (Photo No. 6) is visible. To change position of the Blade, loosen the Clamp Bolt (Photo No. 7) and turn the Index Key until the entire rounded edge shows. The Blade is now unlocked and free to move to the other position.

CAUTION!

Always have the Attachment either blocked or held firmly when you are changing from one position to the other. Because the Attachment, when the Index Key is released, will swing freely unless you have a firm grip on it. Keep it under control or you may hurt yourself or cause the Saw to be damaged.

When you have the Index Key and the Keyway in the Drive Shaft Housing lined up, turn the Index Key until only the flat side shows, and the Saw is locked. Then **TIGHTEN THE CLAMP BOLT TO LOCK THE INDEX KEY, AND ALSO LOCK THE HOUSING TO THE SWIVEL SO THE SAW HOUSING WILL NOT VIBRATE.**

SAW SPEED

Maximum efficiency of the Saw is attained when it is rotating at approximately 1400 RPM. This means that when sawing, the engine should be operating close to wide open in high gear.

ENGAGING THE SAW

Start the tractor motor and set the throttle at idling speed. Engage the Saw by means of the Attachment Clutch Lever on the Advance (front) Casting on the tractor.

FELLING TIMBER

The Saw Blade is used in the horizontal position. Maneuver the Tractor so that the side of the Saw Blade will make contact with the timber to be felled.

The Wheels of the tractor will act as a pivot. Have only the attachment in gear, and then use the handles as levers and engage the Saw with the timber.

When pressure is applied to the Tractor handles, one wheel will move slightly while the other wheel remains stationary.

That is, the wheel nearest the timber will remain stationary, while the other wheel will move. Sometimes you may find that this works best if a block of wood or a stone is placed to "chock" the wheel nearest the tree.

If contact is made too swiftly, you will bind the blade. Make the contact slowly and gradually, let the Saw eat its way through the timber, do not attempt to force it through. If the Saw begins to slow down, back it out a little to allow it to attain its speed again and then re-apply your light but steady pres-

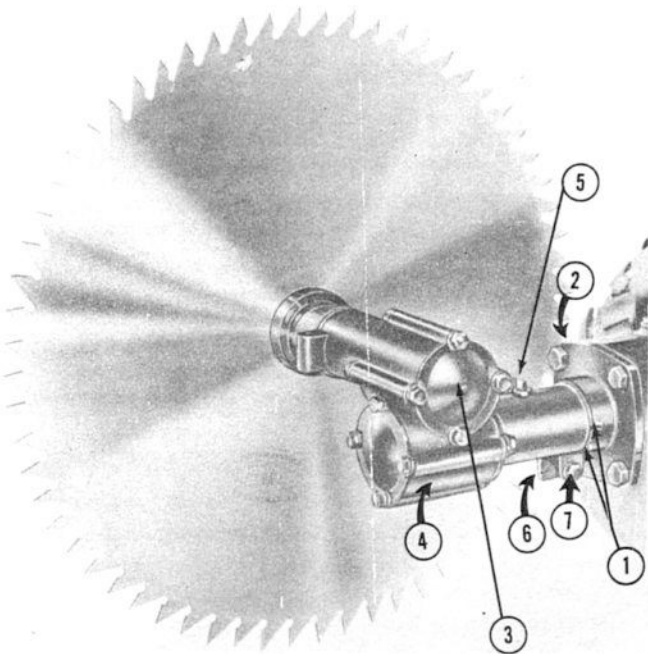

ROTARY SAW

The GRAVELY Rotary Saw Attachment is a power driven circular type saw for the GRAVELY Tractor. It is portable, and capable of cutting and felling timber more than 18 inches thick.

The Blade is of Silver Steel, Grade A, the finest money can buy. It is a high speed Saw Blade, which means that it will last longer, hold the cutting edge longer, and will not warp, wobble or crack.

It is file temper for easy sharpening in the field. The Blade is 26 inches in diameter. The saw has two positions, horizontal and vertical.

ATTACHING

The GRAVELY Rotary Saw is attached to the GRAVELY TRACTOR by four bolts, in the same manner as all other GRAVELY Power Attachments.

When you fit the Drive Shaft Housing (Photo No. 2) to the tractor, be sure that one of the keyways (Photo No. 1) is underneath and one on the right side as you face the tractor from the front.

LUBRICATION

The saw must be in the horizontal position when you lubricate it. This will make the Gear Housing Cap (Photo No. 3) on the Spiral Gear Housing (Photo No. 4) level. Remove this Cap by loosening the four bolts. Fill to one-third full of Mobilube C (SAE 140 Gear Oil). Replace the Gear Housing Cap and Bolts.

The only other point of lubrication is the Pipe Plug (Photo No. 5) on the Swivel Casting. This should receive a little Mobilgrease No. 2 occasionally, to lubricate the Swivel.

Periodically remove the Gear Housing Cap and check the oil. It is wise to do this every day before you start to work.

CARE OF THE SAW BLADE

When your saw is not in use, store it in a dry place. Coat the blade with a rust preventive when you store it, otherwise the rust will pit the Saw Blade, reducing its efficiency. A good coating when storing the Blade for any length of time is Mobilgrease No. 2.

sure.

Do not move the tractor handles up and down, or you will bind the Saw.

You can cut timber up to eight or nine inches in diameter in one cut. However, you should have either a helper to guide the tree, or a heavy pole or rope to keep the tree from falling toward you while you are felling, or you will bind the blade. Caution should be used whenever you are felling timber of any size.

Timber larger than nine inches is felled by making several cuts, depending on the size of the timber. If it is a very large tree, it may be necessary to make a cut on all four sides, although ordinarily a cut on each side of the timber is all that is necessary.

Remember that to fell a tree in a given direction, the cut on that side must be lower. On a large tree, it is sometimes best to make two cuts on one side of the timber, about three inches apart. Then take an axe and knock out the wood between the cuts. Then when the cut is made on the other side of the tree, the tree will fall in the direction of the notch.

Be careful, watch for Kick-Backs (a Kick-Back is the tree butt kicking back toward you when the tree is falling. This is rare, but should be watched for.) Also be careful in windy weather that a sudden gust of wind doesn't change the direction of fall.

TRIMMING

To trim, place the Saw Blade in the Vertical Position.

PLATE EE

The best procedure is to push down on the tractor handles, thus raising the Saw up, over the work. Then raise the tractor handles gradually, letting the Saw work down through the wood. This same procedure is used when sawing the trimmed timber into lengths.

CLEARING LAND

The Saw has proved very effective in clearing land of brush and saplings. The Saw must be in the horizontal position, of course.

The best procedure is to cut an initial path around the area to be cleared. This will be the slowest part of your job, because the Saw is not as wide as the tractor wheels. It will be necessary to cut slowly until you have this initial path cleared. After that, it is simply a matter of walking behind the tractor as the Saw does the work.

You should make sure that the brush and other material falls away from the area in which you will cut the next time. This can be done conveniently if you have another man to help you. If not, you will find it best to move the brush to the right, away from your next cut, as you go along.

By lowering or raising the tractor handles you regulate the distance from the ground that you cut the brush and saplings. You should be sure, however, that the stumps of the saplings are cut close to the ground, not more than four inches above the ground. This is so the chassis will clear the stumps.

ROTARY SAW ASSEMBLY

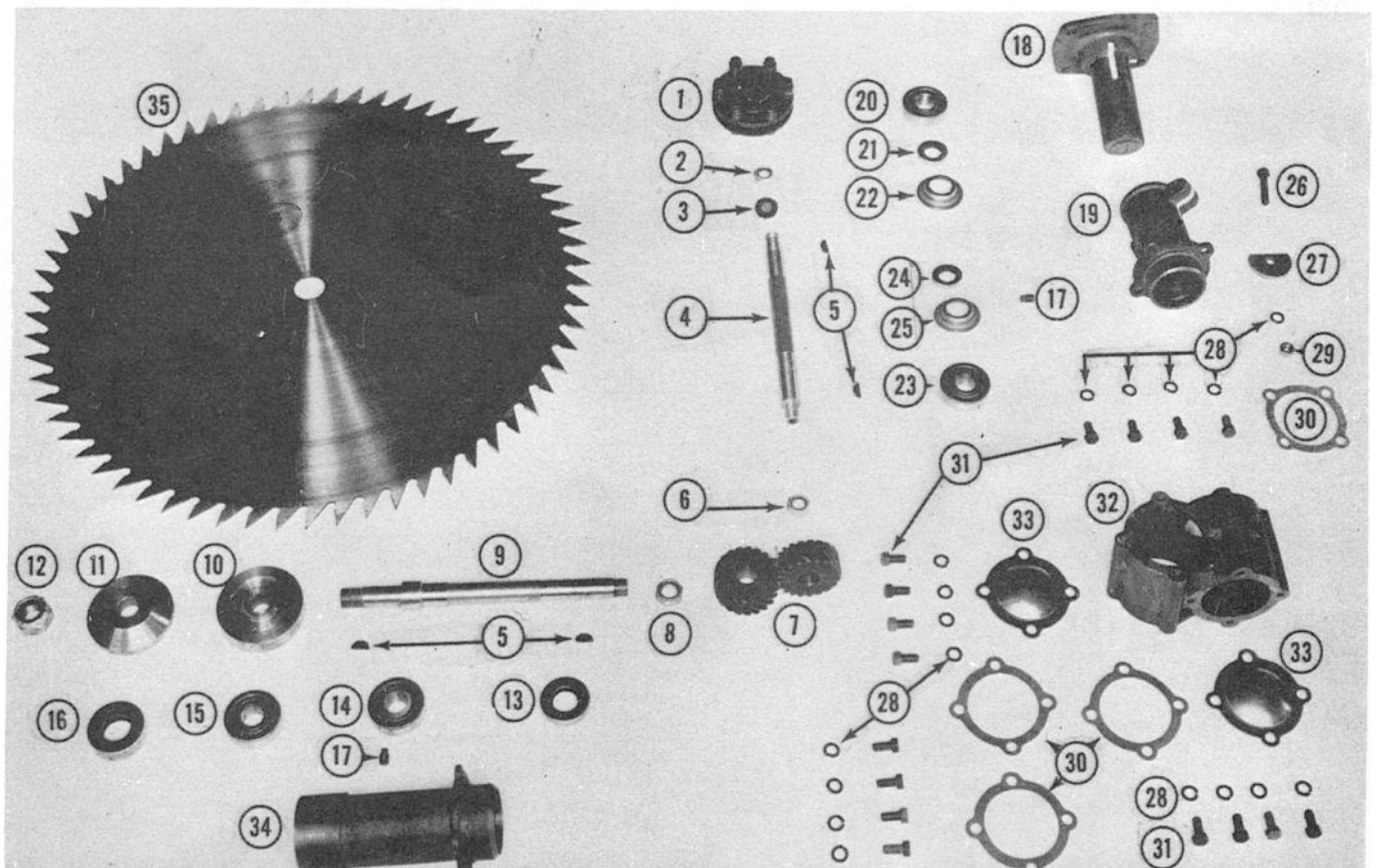

PLATE EE

ROTARY SAW ASSEMBLY SAW GUARD

PHOTO NO.	PART NO.	DESCRIPTION	PRICE
1		Slip Clutch Complete	8.15
2	1304	Drive Shaft Nut	.12
3	309-W	Lockwasher	.02
4	M 308	Drive Shaft, Tapered	1.21
5	504-K	Woodruff Key	.02
6	227-N	Drive Shaft Lock Nut	.18
7	M 318	Spiral Gear	3.30
8	229-N	Saw Arbor Lock Nut	.22
9	A 447	Saw Arbor	4.20
10	A 448	Inner Collar	1.90
11	A 449	Outer Collar	1.65
12	230-N	Saw Collar Lock Nut	.45
13	M 459	Oil Seal	.90
14	3147	Bearing Cone & Cup	2.62
15	A 454	Bearing Cone & Cup	2.62
16	A 452	Oil Seal	1.50
17	701-P	Pipe Plug	.05
18	M 101-S	Drive Shaft Housing	4.03
19	M 102-S	Swivel Casting	3.03
20	3147	Bearing Cone & Cup	2.62
21	L 126	Oil Seal	.56
22	3151	Oil Seal Retainer	.04
23	3147	Bearing Cone & Cup	2.62
24	L 126	Oil Seal	.56
25	3151	Oil Seal Retainer	.04
26	124-S	Clamp Bolt	.05
27	A 451	Index Key	.80
28	305-W	Lockwashers	.01
29	205-N	Clamp Bolt Nut	.03
30	M 326	Gear Housing Gaskets	.05
31	121-S	Gear Housing Bolt	.04
32	M 103	Gear Housing	8.40
33	M 306	Gear Housing Cap	.35
34	A 137	Saw Arbor Housing	3.90
35	A 453	High Speed Saw Blade	30.00
NS	M 139	Housing Adj. Shims .005"	.07
NS	M 139	Housing Adj. Shims .020"	.15

The Saw Guard is an optional safety attachment for the Gravely Rotary Saw. Its purpose is to furnish protection for the Saw Blade when transporting it from one job to another, and to prevent the Saw Teeth from seizing limbs or timber and throwing it in the direction of the operator when sawing firewood, posts, etc.

ATTACHING

To attach the guard to the saw, partially remove the two Clamp Screws (1). Remove the half of the Guard Collar Casting (2) released when you have partially removed the Clamp Screws. Place the Saw Guard over the Saw with the flat strips up, and the circular cut-out portion of the Guard Collar Casting resting firmly against the Saw Arbor Casting, (34 on plate EE). Replace the other portion of the Guard Collar Casting, and tighten down the Clamp Screws.

After the guard is installed, it is a simple matter to rotate it around the saw to any position desired by loosening the Clamp Screws slightly, moving the guard, then tightening the Clamp Screws down again.

DISC HARROW

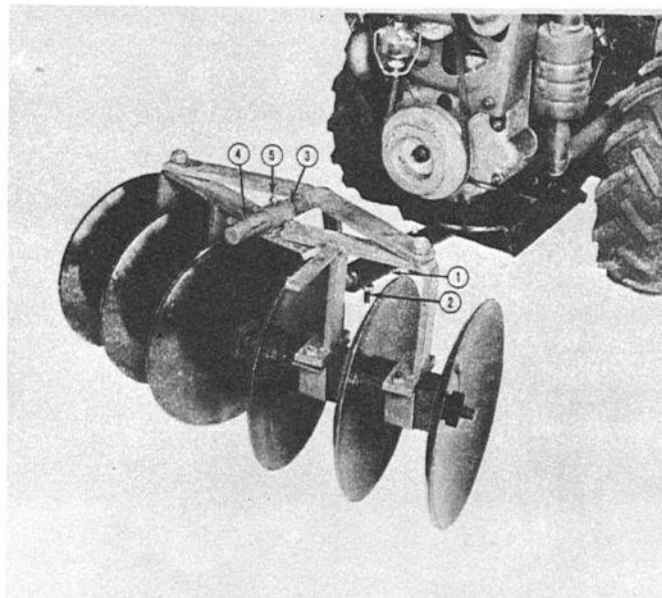

DISC HARROW

The Disc Harrow is used to prepare the seedbed after plowing with a conventional turnplow. It is also used for cultivation, "discing in" cover crops, natural fertilizers, etc.

When the Gravely Rotary Flow attachment is used to prepare the seedbed, the Disc Harrow is not necessary, since the Rotary Flow prepares the seedbed ready for planting in one operation.

The Disc Harrow is attached to the Rear Toolholder (1) by one bolt (2). Adjustment of the angle of the discs is made by moving the pitch sleeve (3) along the pitch adjustment arm (4) holding it in desired position with the cotter pin (5).

SAW GUARD

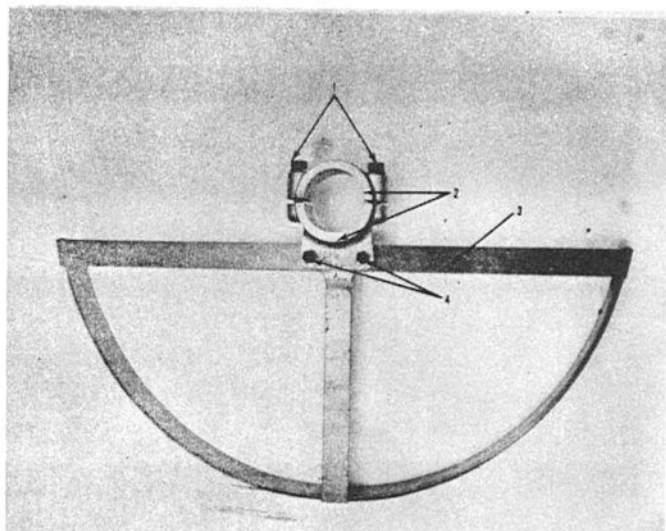

PARTS AND PRICE LIST

PHOTO NO.	PART NO.	DESCRIPTION	PRICE
1	171-S	Clamp Screw	.08
2	PS 101	Guard Collar Casting	3.75
3	PS 309	Rim Assembly	5.25
4	197-S	Rim Securing Screw	.08

GRAVELY GOVERNOR INSTRUCTIONS

MODEL MA-1759

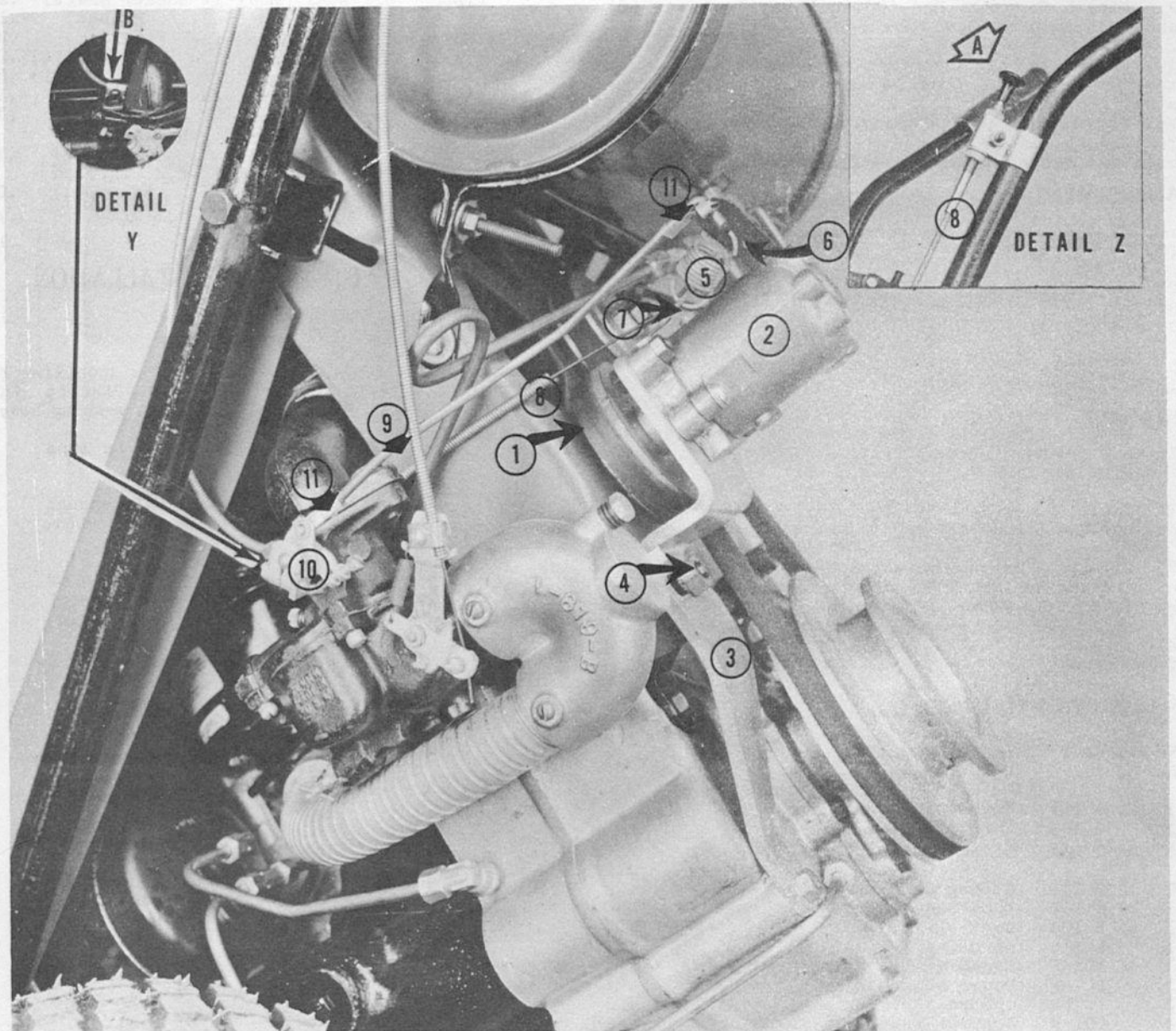

INSTALLATION

1. Mount Governor Pulley (1) on the Governor Assembly (2) by means of the Allen Set Screw, using the L shaped Allen Wrench furnished with the Governor Kit.

2. Install Governor Assembly on the Mounting Bracket (3) by means of the two bolts (Part No. 177-S) and nuts. (Part No. 201-N).

3. Mount Bracket and Governor to crankcase as shown in the photograph. Use the special Long Crankcase Bolt (Part No. L-116) for the bottom hole. Loosen the nut (4) on the Fan Housing and remove it and the washer. The slot of the Mounting Bracket goes over the stud that projects from the Fan Housing. Then replace the washer and nut. At this time move the bracket clockwise until the Governor Pulley comes into firm contact with the fan belt. Then tighten the nut (4) down securely.

4. Mount the Boden Wire Assembly (8) to handle. See Detail Z on the photograph.

5. Mount Clip (B in Detail Y) under manifold bolt head and loop the Wire Assembly through it as illustrated. If the gas line is assembled in a slightly different manner than shown in the photograph, you may have to put the clip on the manifold bolt nearest the governor. Either way is correct as long as there is no interference between the wire assembly and the gas line.

6. Couple Governor Spring (5) to center hole in Throttle Lever (6).

7. Hook Spring Connector (7) to Governor Spring, then hook the end of the Eoden Wire Assembly (8) into the Spring Connector.

GOVERNOR INSTRUCTIONS

8. Now pull out the Hand Throttle Control (A in Detail Z) as far as it will go. This will put tension on the Governor Spring (5).

9. Attach Throttle Rod (9) to Throttle Lever (6) and Bellcrank (10) with the clips (11) provided.

10. Remove the old Throttle Control Bellcrank. Place the carburetor valve in the wide open position. Install the Bellcrank (10) on the carburetor Throttle Valve shaft (the shaft from which you removed the old Bellcrank) and clamp securely by means of the small bolt and nut on the Bellcrank.

ADJUSTMENTS

1. Five holes are provided in the Throttle Lever (6) for adjustment.

2. To INCREASE Governor Sensitivity--hook Governor Spring (5) in hole nearer Throttle Lever Hub on Governor.

3. To Remove LOAD SURGE--hook Governor Spring (5) in hole further from Throttle Lever Hub.

TROUBLE SHOOTING

If your Governor is not responding properly, check these points.

1. Check to see that Governor Pulley (1) is bearing against Fan Drive Belt and is being driven properly.

2. With tension on Governor Spring, engine NOT running, check Bellcrank (10) to be certain that Carburetor Throttle Valve is held wide open.

3. Be certain that Throttle Rod (9) is free from friction.

PARTS PRICE LIST

NO REQ'D	PART NO.	DESCRIPTION	PRICE
1	G 101	Governor	24.50
1	G 102	Throttle Rod	.25
1	G 104	Boden & Wire Throttle Assy. Clip	.15
1	G 105	Spring Connector	.08
1	G 106	Mounting Bracket	1.20
1	G 107	Control Bracket	.25
1	L 116	Mounting Bracket Bolt	.14
1	102-S	Boden & Wire Clip Screw	.02
1	207-N	Boden & Wire Clip Screw Nut	.01
3	177-S	Control Bracket & Mounting Screw	.03
3	201-N	Control Bracket & Mounting Screw Nut	.02
1	A2796	Spider and Shaft Assembly	3.50
1	A3810	Body and Bushing Assembly	6.65
2	G3168	Bushing for A-3810	.40
1	G9021-15	Body for A3810	5.65
1	A4328	Pulley Assembly	3.00
1	A4504	Throttle Lever Assembly	1.00
1	G3168	Bushing (Body at Drive Shaft)	.40
1	G8075	Plug (Body at Rocker Shaft)	.20
1	G8883	Weight Pin	.10
1	G9121-8	Flange	4.50
1	G9821-1	Swivel Yoke	1.25
1	G9843	Thrust Sleeve	1.50
1	G10126	Rocker Shaft	1.00
4	G8650-PM	Governor Weight	1.00
1	SN-5	Spring	.85
2	X-455	Escutcheon Pin	.10
1	X-121	Set Screw $\frac{1}{4}$ -20x $\frac{1}{2}$ (Pulley)	.10
2	X-1050	Lock Washer (Body to Flange)	.10
1	X-1158	Groove-Pin 3/32x5/8 (Hub in Lever)	.15

1	X1221	Oil Seal (Flange)	.40
1	X-1244-1	Name Plate	.25
2	X1300	Ball Bearing (Flange & Thrust Sleeve)	2.00
1	X1413	Gasket	.15
1	X1555	Oil Seal (Body at Rocker Shaft)	.20
2	X1619	Rd. Hd Screw (Body to Flange)	.15
1	X1914	Internal Snap Ring (Flange)	.25
1	X1915	External Snap Ring (Drive Shaft)	.25
1	X1923	External Snap Ring (Drive Shaft)	.20
4	X1983	Retaining Ring (Weight Pins)	.10
1	AC-575	Carburetor Bellcrank	.35
1	C-598	Throttle Rod Clip R.H. (Thr. Rod at Lever)	.17
1	C-858	Throttle Rod Clip L.H. (Thr. Rod at Carb.)	.08
1	G 103	Boden & Wire Throttle Assy.	1.20
NS	G 108	Throttle Lock	.10

IMPORTANT CAUTION FOR INSTALLATION OF GOVERNOR PULLEY

Unless your governor pulley is mounted according to these instructions, you will have difficulty with the rubber bonded surface of the pulley wearing away.

1. Be sure that the pulley is in line with the Fan Belt.
2. Be certain that there is only enough pressure to operate the Governor without slippage.
3. Be certain that the flat surface of the Fan Belt contacts the surface of the pulley evenly, and not at an angle.

WRONG

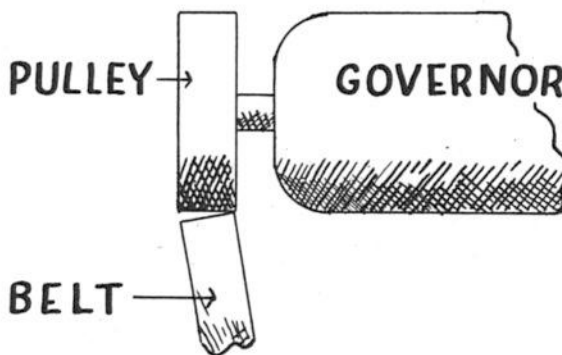

RIGHT

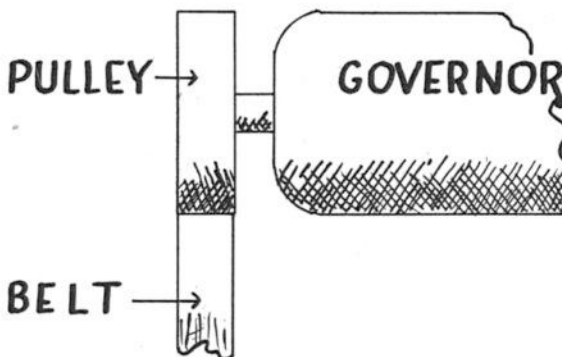

PEG TYPE HARROW

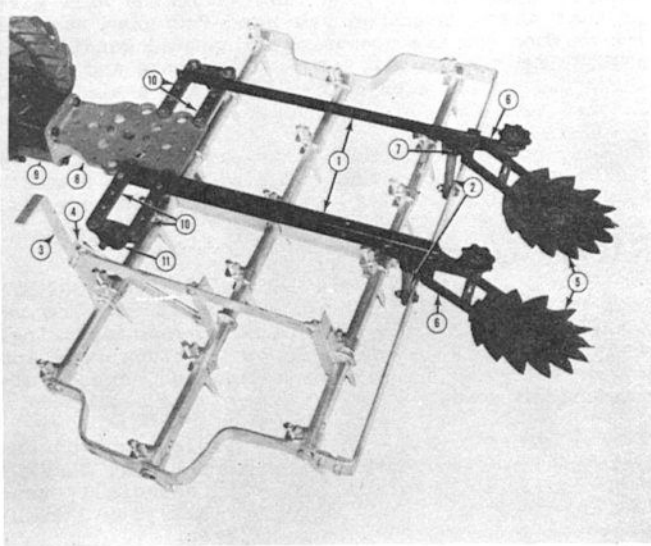

The Gravely Peg Type Harrow prepares the soil for seeding after plowing with the conventional turn plow; it is not used after plowing with the Rotary Plow, which in one operation leaves the seedbed ready for planting. For best results with the Peg Type Harrow, carefully read the instructions below.

OPERATING

The pegs may be locked at the desired pitch by means of the Pitch Adjustment Lever and the Pitch Lock.

The function of the Depth Wheels is to support the harrow at the desired depth in the soil. The depth may be regulated by turning the Depth Adjustment Screw.

If the soil is unusually hard a heavy weight may be placed on the Harrow.

ATTACHING

The Gravely Peg Type Harrow comes to you completely assembled. Two angle irons (1) and two Support Pins (2) are included for attaching the Harrow to the tractor. To attach proceed as follows:

1. Lock the pegs in vertical position, using Peg Pitch Lever (3) and Peg Pitch Lock (4).
2. Bolt Support Pins in place on inside of front bar and set them in vertical position.
3. Using the Depth Wheels (5) and Depth Wheel Brackets (6) from your cultivator, bolt an angle iron to each Depth Wheel Bracket as shown in Plate FF.
4. Slip each Depth Wheel Bracket over a a Support Pin and push down firmly until the Support Pin is against the angle iron, then lock in place with the Shank Clamp Bolt (7).
5. Fasten the Front Toolholder Frame (8) to the Toolholder Casting (9) with the customary four bolts. Use only

two parallel bars (10) on each side of the Toolholder Frame, bolted to the first and third holes from the front of the Toolholder Frame and extending at right angles to it. For firm support fasten a Shank Clamp (11) between the free ends of each pair of parallel bars, as shown in Plate FF.

6. Fasten the free end of each angle iron to the parallel bars as shown in Plate FF. From operator's position between the tractor handles, the right angle iron should be bolted to the two holes nearest the Toolholder, and the left angle iron should be bolted to the two holes nearest the Shank Clamp. This arrangement reduces side drag and makes harrowing easier.

DUAL WHEELS

Dual Wheels increase the working ability of your Tractor because they give you more traction. They lower the center of gravity on your Tractor and make the work on steep slopes and hillsides easier. These wheels will enable you to work on grades as steep as 60%.

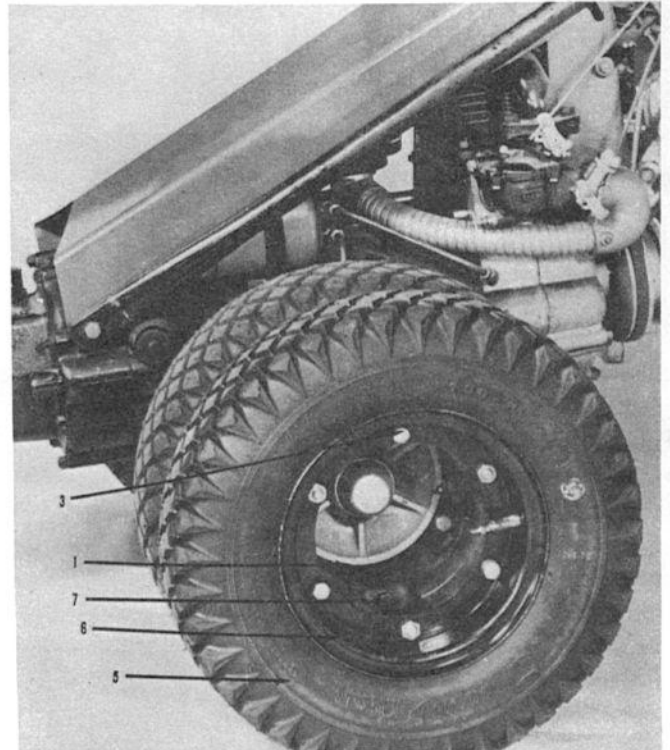

PARTS AND PRICE LIST

PHOTO NO.	PART NO.	DESCRIPTION	PRICE
1	L 918	Dual Wheel Spacers, each:	7.87
2	179-S	Rim Securing Bolts, each:	.06
3	305-W	Washers, for all bolts, each:	.01
4	205-N	Rim Securing Bolt Nuts, each:	.03
5	L 616	Tire, each: (Incl. Fed. Tax)	8.22
NS		Tube, each: (Incl. Fed. Tax)	2.14
6	L 616-A	Wheel Discs, each: (Two Wheel Discs make up each Rim)	1.09
7	195-S	Spacer Securing Bolts, each:	.10
7	205-N	Spacer Securing Bolt Nuts, each:	.03

WATER BALLAST ROLLER

If you want a velvet-smooth lawn, let the GRAVELY Water Ballast Roller help you. The Roller when filled with water weighs about 750 pounds.

The Roller will level your lawn, take out the unsightly bumps and depressions. And more important still, the compacting of the soil will give you a close-knit, firmly rooted lawn, resistant to disease, weeds, and drouth. The Roller will follow the contour of the ground and this enable you to do a better job.

The edges are rounded to prevent cutting or injury to your lawn. You have plenty of power with the GRAVELY Tractor to pull this load and you will find that the Water Ballast Roller does a fast and efficient job!

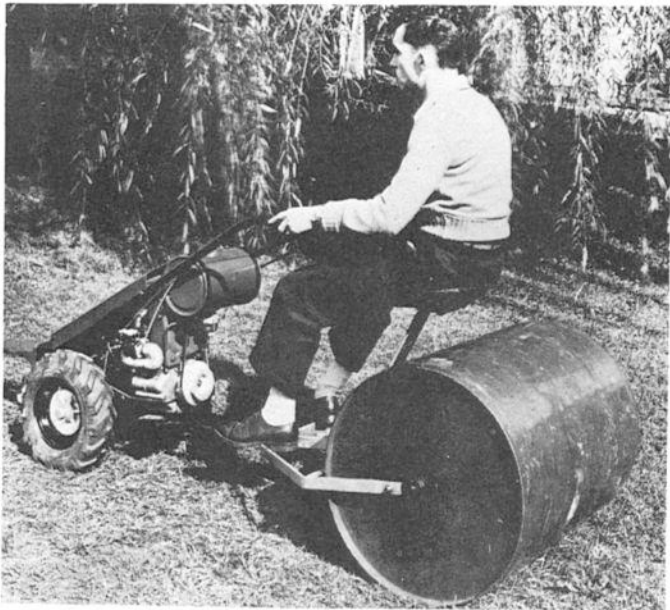

PARTS AND PRICE LIST

PHOTO NO.	PART NO.	DESCRIPTION	PRICE
	A-443-1	Roller Drum 24 x 32"	36.00
	A-443-2	Bearing Complete (Bearing Rollers only .02 ea.)	2.40
	A-443-F	Frame	9.50
	137-S	Frame Bolt	.04
	205-N	Frame Bolt Nut	.03
	305-W	Lock Washer	.01
	A-443-10	Seat Spring	3.45
	160-S	Seat Spring Bolts	.08
	A-443-12	Seat, Steel	1.80
	180-S	Seat Bolt	.07
	211-N	Seat & Seat Spring Bolt Nuts	.05
	308-W	Spring Bolt Lock Washer	.01
	412-W	Bearing Flat Washer	.05
	603-C	Axle Cotter Pin	.01

CUSHION

The new GRAVELY Tractor Cushion for the Riding Sulky means more comfort and ease to you while you work! The Cushion is built to take hard wear, being filled with shredded Foam Rubber underneath a cover of Plastic Coated Fabric.

This new Cushion can be tied on in 10 seconds and once in use it will give you hours of comfortable riding.

TIRE CHAINS

When it is snowy or wet you'll need GRAVELY Tire Chains. These tough, long lasting chains will give you that extra traction you need for snow removal work or when you are operating in unusual conditions. GRAVELY Tire Chains are heavy duty bronze and steel, have cross chains every other link, and a simple and positive lock that fastens them on in a moment's time.

The electrically welded chains are smooth so they will be easy on your tires, yet give positive traction when you need it. In icy, snowy or wet weather you'll need GRAVELY Tire Chains.

TRACTOR COVER

You can add life to your Tractor by using the GRAVELY Tractor Cover. It is designed to protect your Tractor from weather, fire and water damage, and tampering. It's built to last--of fireproof, mildewproof and waterproof heavy duck, with reinforced edges, cut-outs and grommets.

It fits snugly down over the handles and to the ground. When your Tractor is stored, the GRAVELY Cover should be in place. This is especially true when the Tractor is left outside. Ask your GRAVELY Dealer to show you the Tractor Cover.

SICKLE GRINDER

To do good sickle mowing, you need sharp knives. The GRAVELY Sickle Grinder is capable of sharpening 6 Knife Sections at a time before reclamping, is simple to operate and will keep your knife sections sharp for a good, clean mowing job. Anyone can operate the grinder, and it only takes a few moments to sharpen the knives.

The grinder is constructed to give the correct angle to the cutting edge. All you have to do is clamp the knife and grind! So get a Sickle Grinder and keep your mowing attachments in tip-top shape all the time.

PUNCTURE PROOF TIRE TUBES

In many sections of the country thorns are prevalent in the turf to the extent that tire punctures are a major problem. Therefore there is available to our users a high grade puncture proof tube.

The tube should be ideal for all users, not just the ones who are in the group described above. The small investment in these tubes would be repaid over and over again by the saving in time and money repairing flat tires.

OIL PRESSURE GAUGE

A new Oil Pressure Gauge which eliminates the necessity for taking off the oil filler cap and checking the pumping of oil is now in stock at your GRAVELY Dealers. This gauge is inexpensive, can be installed by yourself if you wish. Full instructions for installation are with the gauge.

Equipment:

- 1 Extension adapter
- 1 Pressure Gauge
- 1 Tubing Ferrule

Installation:

The following steps should be taken in the exact order indicated to obtain proper installation and operation.

1. Raise hood covering motor and locate oil filter. (The oil filter is a cylindrical, bell-shaped, "can" attached to the

motor and has two copper tubes coming from it one of which goes to the Crankcase of the engine and the other to the Relief Valve of the engine.)

2. Of the two copper tubes coming from the filter, the gauge is to be attached to the line coming from the center of the oil filter through an "L" and thence to the motor. (Note: Do not detach the line coming from the "T" connection which is set slightly below the "L" on the oil filter.) Having located the line to which the pressure gauge is to be attached, loosen the nut holding the copper tubing to the "L" fitting and pull the tubing away from the "L".

3. From your kit, attach the adapter to be the "L" from which you have removed the tubing. When you are finished, be certain the threaded opening on the side of the adapter is in an upright position. Then, attach the tubing to the end of the adapter.

4. Insert the pressure gauge in the threaded opening on the adapter and tighten until firm and until the gauge faces the handles of the Tractor.

5. Start the motor. Watch for any oil leaks and tighten connections needing same. As motor is speeded and slowed, the pressure gauge should likewise increase and decrease

SNOW BLOWER

Now you keep walks and drives clear of snow without back-breaking drudgery. Power does the work when you use the new Gravely Snow Blower Attachment for the powerful Gravely Tractor!

The Gravely Snow Blower handles snow up to four feet deep; picks it up clean, throws it as much as thirty feet, right or left, at any angle you desire. Don't worry if other snows come while the first ones are still banked beside your walk or drive—the Gravely Snow Blower puts the snow over the top of the deepest drift! Runners let you skim the snow from any walk or drive, even Bluestone or Gravel! All gear drive and welded steel construction means you will get years of dependable service from your Gravely Snow Blower.

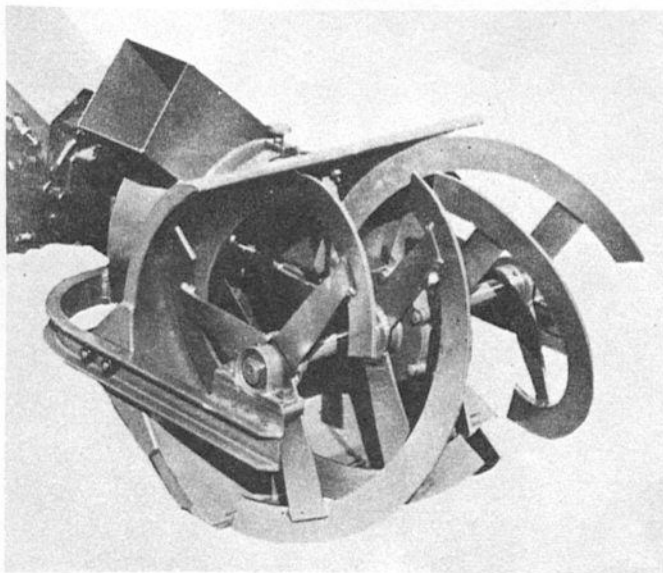

WING TRANSPORT BRACKET

To install simply remove the top two bolts in the M 153 Strut and bolt the Wing Transport in place as shown. The circular cut out on the rear of the transport simply rests on the Swivel Casting. There is a hole in the top of the Wing Transport to allow the user to remove the oil filler plug easily and add oil.

To operate, simply pick up the wing unit and place the rollers in position in the half moon shaped brackets on the top plate. The wing units will be held firmly in place.

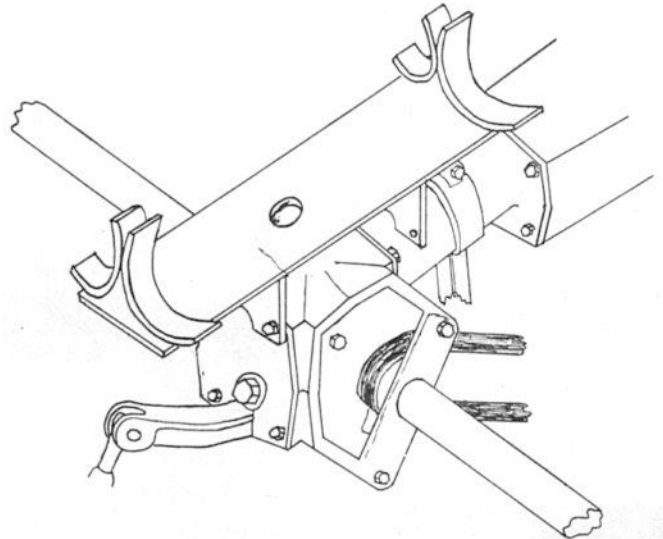

Guarantee

The GRAVELY Tractor and Attachments are guaranteed to be free from defective material and workmanship for a period of ninety (90) days and all defective parts will be replaced without charge, provided such parts are returned to our factory, transportation charges prepaid, and in our opinion after inspection are defective, and have not been damaged through neglect of operation.

IMPORTANT

This is your guarantee, but it is not valid or effective unless within seven days after delivery of your equipment you complete the "Guarantee Registration Card" and mail it to

GRAVELY MOTOR PLOW & CULTIVATOR COMPANY
DUNBAR, WEST VIRGINIA

MAIL THIS
REGISTRATION
GUARANTEE
CARD NOW

HELP YOUR
FRIENDS LEARN
ABOUT THE
GRAVELY

YOUR GUARANTEE and
Registration card are in this
Instruction Book. Be sure to
return the registration card to

**Gravely Motor Plow &
Cultivator Co.**

NOW!